

# CEMINTEL®



## TABLE OF CONTENTS

<b>01 INTRODUCTION</b>	<b>2</b>	Tiling	13
Introduction	2	Maintenance	13
<b>02 PRODUCT OVERVIEW</b>	<b>3</b>	<b>06 COMPONENTS + ACCESSORIES</b>	<b>14</b>
CeminSeal® Wallboard Information	4	<b>07 SYSTEM ENGINEERING</b>	<b>18</b>
Product Specifications	4	Design, Detailing and Performance	
<b>03 SYSTEM OVERVIEW</b>	<b>5</b>	Responsibilities	19
Applications	6	Cemintel Wallboard Systems	20
Benefits of Cemintel® CeminSeal®		<b>08 INSTALLATION</b>	<b>26</b>
Wallboard Systems	6	Sheet Preparation	27
Product Specifications	6	Sheet Fixing	27
<b>04 'WET AREA' WALL DESIGN</b>		Back-blocking	29
<b>CONSIDERATIONS</b>	<b>7</b>	Back-Blocking Installation Procedure	29
<b>05 DESIGN + AESTHETIC</b>		Caulking	29
<b>CONSIDERATIONS</b>	<b>9</b>	Jointing & Finishing	29
General	10	<b>09 CONSTRUCTION DETAILS</b>	<b>34</b>
Surface Finishing & Lighting	10	<b>10 JOINTING + FINISHING</b>	<b>47</b>
Consideration To Minimise		Jointing and Finishing	48
Glancing Light	10	Jointing Procedure	50
Windows	10	Jointing of Internal Corners	51
Joint Orientation	10	Jointing of External Corners	52
Applied Finish Selection	10	Decoration	53
Inspection of Wallboard	11	<b>11 SAFETY, HANDLING, GENERAL CARE</b>	
Framing	11	<b>+ WARRANTY</b>	<b>54</b>
Nogging	12	Health, Safety and Personal Protection	
Wind loads	12	Equipment (PPE)	55
Seismic Loads	12	Safety, Handling and Maintenance	55
Control Joints	13	Warranty	55
Fixtures	13		

## Introduction

CeminSeal® Wallboard ('Wallboard') features an embedded water-block technology that prevents water from penetrating the sheet. This provides a more stable sheet ideal for lining areas such as bathrooms and laundries. The robustness of fibre cement also makes it a suitable lining for the construction of impact resistant walls.

Wallboard is an autoclaved, cellulose fibre reinforced cement sheet with a smooth flat surface. It has a recess on both long edges, so that sheets may be taped and flush-set with CSR Gyprock and Cemintel™ jointing materials. Once jointed it may be tiled, directly or over a waterproof membrane, or it may be painted.

This CeminSeal® Wallboard Design and Installation Guide recommends good building practice and

has been prepared as a general guide of design considerations, system engineering information and installation procedures for common and 'wet area' interior wall applications. It assumes that the user has an intermediate knowledge level of building design, waterproofing and construction. In no way does it replace the services of the building professionals required to design projects, nor is it an exhaustive guide of all possible scenarios.

It is the responsibility of the architect, designer and various engineering parties to ensure that the details in this Design and Installation Guide are appropriate for the intended application. For further design information this guide should be read in conjunction with National Construction Code (NCC), Australian Standards, regulatory requirements and project specifications.

A large, stylized graphic of the number '022' in a light gray, outlined font, positioned in the lower half of the page. The '0' is a simple oval, the first '2' has a curved top, and the second '2' is more angular.

# PRODUCT OVERVIEW

## 02

## PRODUCT OVERVIEW

**CeminSeal® Wallboard Information**

CeminSeal® Wallboard (“Wallboard”) sheet is autoclaved, cellulose fibre reinforced cement sheet. Sheets of 6mm nominal thickness are available with nominal widths of 900, 1200 and 1350mm, and 9mm and 12mm nominal thickness sheets are available with a nominal width of 1200mm, and a range of lengths. Wallboard RE features a ‘Recessed Edge’ finish on the two long edges which facilitates concealed joint construction, and Wallboard SE has all ‘Square Edge’ edge finishes for non-set expressed joints.

Wallboard sheets conform to the requirements of AS/NZS 2908.2: Cellulose-cement products, Part 2 – Flat sheets for Type B Category 3.

In accordance with the NCC 2022 C2D10 (5)(d) [NCC 2019: C1.9 (e)(iv)], Wallboard sheets can be used wherever non-combustible material is required.

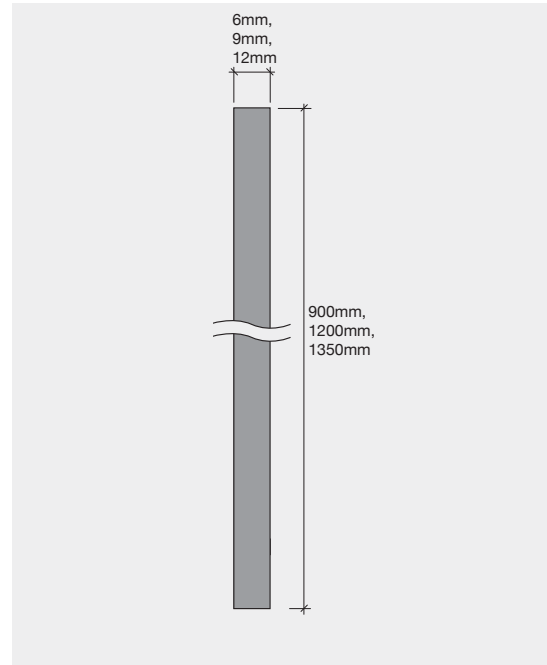

Thickness (mm)	Long Edge Finish	Width (mm)	Length (mm)	Mass (Nominal)	Product code	
					RE	SE
6	RE	900	3000	9.4kg/m <sup>2</sup>	95826	
6	RE	1200	1800	9.4kg/m <sup>2</sup>	95827	
6	RE, SE	1200	2400	9.4kg/m <sup>2</sup>	95828	95850
6	RE, SE	1200	2700	9.4kg/m <sup>2</sup>	95829	95851
6	RE, SE	1200	3000	9.4kg/m <sup>2</sup>	95830	95852
6	RE, SE	1200	3600	9.4kg/m <sup>2</sup>	95841	95861
6	RE	1200	4200	9.4kg/m <sup>2</sup>	95842	
6	RE	1350	2400	9.4kg/m <sup>2</sup>	95843	
6	RE	1350	3000	9.4kg/m <sup>2</sup>	95844	
6	RE	1350	3600	9.4kg/m <sup>2</sup>	95845	
6	RE	1350	4200	9.4kg/m <sup>2</sup>	95846	
9	RE	1200	2400	14.5kg/m <sup>2</sup>	95847	
9	RE, SE	1200	2700	14.5kg/m <sup>2</sup>	95848	95862
9	RE, SE	1200	3000	14.5kg/m <sup>2</sup>	95849	95863
12	RE	1200	3000	18.8kg/m <sup>2</sup>	95825	

**Product Specifications**

Property	Specification	Tolerance	Reference/Relevant Standard
Thickness	6, 9, 12 mm	+0.5 / -0.0mm	AS/NZS 2908.2
Width	900, 1200, 1350 mm	+0.0 / -3.0mm	AS/NZS 2908.2
Length	1800, 2400, 2700, 3000, 3600, 4200 mm	+0.0 / -4.0mm	AS/NZS 2908.2
Nominal Density	1550kg/m <sup>3</sup>		

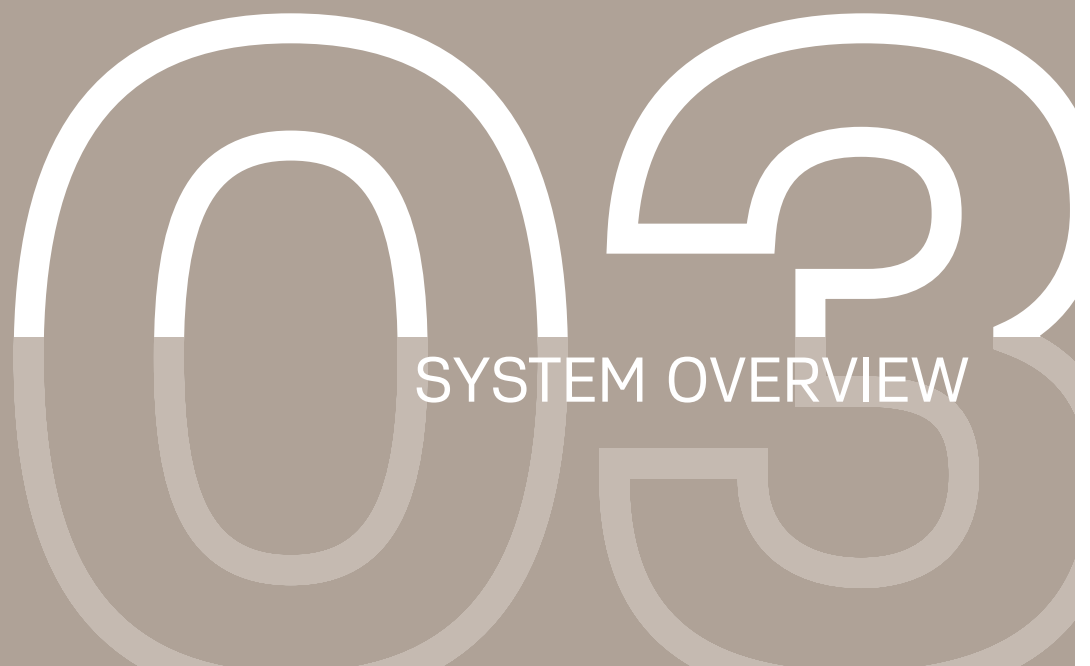
A large, stylized graphic of the numbers '03' in a light beige color, serving as a background for the title. The '0' is a simple oval, and the '3' has a curved top and a vertical stem.

# SYSTEM OVERVIEW

## 03

## SYSTEM OVERVIEW



### Applications

The lining systems in this manual are suitable for interior non-load bearing and non-fire rated steel framed walls. Details are provided for wet areas such as showers, for other areas in bathrooms and laundries, and for non-wet areas where fibre cement is specified, such as for walls susceptible to damage. Details for load-bearing timber and steel framed walls typically found in Class 1 buildings can be found in the manual, 'Cemintel Wet Area Systems – Residential Interior Wet Area Lining & Flooring Systems'.

Wet area details are based on the National Construction Code (NCC) and Australian Standard AS 3740:2021 'Waterproofing of domestic wet areas'. The standard details the design, materials, and installation requirements for wet areas within Class 1, 2 and 4 buildings, as well as those within other buildings having similar levels of use, including sole occupancies in Class 3 buildings.

### Benefits of Cemintel® CeminSeal® Wallboard Systems

- CeminSeal® water blocking technology, perfect option for wet areas.
- High adhesive, provides an excellent substrate for tiled finishes.
- High impact resistance, provides a tough, durable wall lining system especially for high traffic areas.
- Fire resistant.
- Termite resistant.
- Lightweight construction method.
- 4.2m long panel allows quicker installation with less butt joints.

### Product Specifications

A Technical Data Sheet can be downloaded from [cemintel.com.au](http://cemintel.com.au)

Property	Performance	Reference/Relevant Standard
Tiled Finishes	Suitable for tile finishes up to 32kg/m <sup>2</sup>	
Wind Actions	Suitable for up to 1kPa internal pressures	AS/NZS 1170.2
Fire Resistance Level (FRL)	Up to -/120/120 when used in a system with Gyprock fire grade plasterboard	Refer to Gyprock The Red Book
Combustibility	Classified as a "non-combustible material" under the NCC deemed to satisfy provisions.	NCC 2022 C2D10 [2019: C1.9]
Surface Burning Characteristics	Early Fire Hazard Properties are - Ignitibility Index = 0 Spread-of-Flame Index = 0 Heat Evolved Index = 0 Smoke-Developed Index = 1	AS/NZS 1530.3
Fire Hazard Properties	Group Number = 1 Average Specific Extinction Area <250m <sup>2</sup> /kg SMOGRARC ≤0.2	AS ISO 9705 AS 5637.1

# 04

'WET AREA' WALL DESIGN  
CONSIDERATIONS

## 04

## 'WET AREA' WALL DESIGN CONSIDERATIONS

**A wet area is defined as an area within a building supplied with water from a water supply system, including bathrooms, showers, laundries, and toilets, but excluding kitchens, bars and similar. Each wet area is classified as having a high, medium, or low level of risk. Certain walls and junctions in each of the levels are required to be waterproof or water resistant.**

The wet area details provided are based on an interpretation of those provided in the National Construction Codes (NCC) and Australian Standard AS 3740:2021 'Water proofing of domestic wet areas'. The nominated extent and type of waterproofing treatment varies between NCC 2019 and NCC 2022, and the drawings in this guide should be considered as conceptual and are not intended to replace the NCC, Australian Standards and project specifications, nor to overrule the expertise of builders and waterproofing contractors.

The 'wet area' wall areas that occur within an enclosed or unenclosed shower area compartments and walls adjacent to vessels, such as baths, spas, and basins will require a waterproofing system treatment. Typically, the 'wet area' wall construction consists of a water-resistant Wallboard substrate, waterproofing treatment of critical areas, and an appropriate covering of water-resistant surface material tiles and adhesive. The critical areas that may compromise the waterproofing system in showers and bathrooms, and near baths, spas, sinks etc., include:

- Floors, including any hob or step-down.
- Junctions and joints between walls (i.e., corners).
- Rebates and steps in the wall.
- Junctions between floors and walls.
- Joins and in the sheeting.
- Penetrations (i.e., taps, pipes, fixings).

Depending on the Building Classification and applicable NCC, these critical areas or the entire 'wet area' wall will require treatment with a waterproof material, such as waterproofing membrane.

Membranes for waterproof areas are classified as Class I, Class II or Class III, with Class III having the greatest elongation capabilities. Only Class II or Class III membranes are recommended at wall-to-wall junctions due to their ability to span small gaps between the wall linings.

Cemintel recommends a waterproofing system consisting of a waterproof membrane over the Cemintel fibre-cement substrate walls within an enclosed or unenclosed shower area compartments and walls adjacent to vessels. Additionally, the floor areas within the bunded perimeter of a wet area should be waterproof as required. This guide considers the treatment of walls and wall-to-floor junctions in these areas and tries to distinguish between the mentioned critical areas.

Following are a couple of terms within the NCC and AS 3740 to describe the waterproof and water-resistant requirements of materials and systems, and assist in determining the adequacy of the 'wet area' wall system, which include:

- **Waterproof**, the property of a material that does not allow water to penetrate through it.
- **Water-resistant**, the property of a system or material that restricts water movement and will not degrade under conditions of water.
- **Water-resistant substrate**, fibre-cement sheeting manufactured to AS/NZS 2908.2.
- **Water-resistant surface material**, tiles when used in conjunction with a water-resistant substrate.
- **Shower area**, the area affected by water from a shower, including a shower over a bath and for a shower area that is:
  - **Enclosed** – the area enclosed by walls or screens including hinged or sliding doors that contain the spread of water to within that space; or
  - **Unenclosed** – the area where, under normal use, water from the shower rose is not contained within the shower area.





DESIGN + AESTHETIC  
CONSIDERATIONS

## 05

## DESIGN + AESTHETIC CONSIDERATIONS

**This guide provides detailed installation information for cladding systems with Cemintel Wallboard on non-loadbearing steel frame construction. This section outlines some important areas for consideration in determining an appropriate design of the Cemintel Wallboard Systems. The following points are not exhaustive. It is the responsibility of the architect / building designer to ensure the design conforms to NCC requirements and other relevant building standards that may exist for that location. It is recommended that the architect/building designer assigns the responsibility for the wall design to the project engineer.**

### Surface Finishing & Lighting

Under most lighting conditions, a Wallboard lined surface finished with standard methods will appear smooth and flat. In critical lighting conditions, an effect referred to as glancing light, any surface variations will be highlighted. This is due to factors such as the hand-finished nature and build height of jointing and the subtle differences between the surface textures of the lining and the jointing compounds.

Glancing light (or critical light) is a condition which exists when light hits the wall surface at an acute angle and casts shadows. This can make the surface look uneven and highlight the appearance of joints.

This is commonly found in situations where there are:

- Floor to ceiling windows.
- Windows directly adjacent to walls.
- Wall lights, or ceiling downlights close to walls.
- Windows at the end of long corridors.
- Brightly lit rooms.
- Clerestory windows.
- Reflections of light from water features.

### Consideration To Minimise Glancing Light

The best time to consider potential glancing light issues is during the design phase, which allows choices to be made that can greatly reduce the impact of glancing light. Large window areas are a popular feature of modern design and the preference for open plan living and working often results in ceilings and walls that extend through different spaces. These features can lead to challenging lighting conditions for wall and ceilings surfaces.

It is important to consider the effect of both natural and artificial light and how it will fall on the walls across the whole day. Attention should be given to light entering the building in mornings and evenings when the sun is lower in the sky and casts elongated shadows that can highlight any surface variations in walls and ceilings.

### Windows

For windows that are positioned where glancing light can be an issue, the use of external shading or vertical louvres may help to mitigate problems. Curtains or interior blinds can also be helpful. Rooms with windows in two orientations providing more uniform natural light can reduce the effects of critical light.

### Joint Orientation

The orientation of wall linings can significantly impact the appearance of the surface. Running the sheets so that the long joints are parallel to the direction of the light will help reduce the effects of glancing light. For example, in corridors with windows at the ends, horizontal sheeting is recommended as most of the joints often will be parallel to the light direction. The use of longer sheets to reduce the number of butt joints is also beneficial.

### Applied Finish Selection

The wall finish plays an important role in determining the effects of glancing light. The wall surface comprises two materials, being the Wallboard surface and the jointing compound, which have different textures and porosities.

To achieve a consistent finish across these materials it is vital that a primer sealer is applied. AS/NZS 2311, 'Guide to the painting of buildings', requires that a sealer plus two coats of water-based paint must be applied as a minimum. Such a system will provide a surface with minimal difference in texture and porosity.

Roller application for all coats is strongly recommended as it imparts a light texture to the surface and minimises visible differences. If spray application is used, each paint coat should be back rolled while still wet, to create a lightly textured finish, and allowed to dry completely before applying the next coat. Paint applied with a longer nap roller tends to mask imperfections better than coating systems applied with a short nap roller.

## DESIGN + AESTHETIC CONSIDERATIONS

05

The choice of gloss level can also have a significant impact on the perceived quality of the surface in glancing light conditions. A matt paint finish provides the highest level of light diffusion and helps to disguise any surface irregularities. It is recommended that a matt finish be used in areas where a higher gloss is not required for functional reasons. Textured or heavy patterned finishes tend to hide imperfections. Lighter colours can also help. Higher gloss levels can accentuate surface variations, while satin, low-sheen or semi-gloss paints can reduce the risk of mould in wet areas.

### Inspection of Wallboard

The Guide to Standards and Tolerances (Victorian Building Commission 2015) outlines the following standard for inspection of vertical and horizontal surfaces.

“Generally, variations in the surface colour, texture and finish of walls, ceilings, floors and roofs, and variations in glass and similar transparent materials are to be viewed where possible from a normal viewing position. A normal viewing position is looking from a distance of 1.5 m or greater (600 mm for appliances and fixtures) with the surface or material being illuminated by non-critical light. Non-critical light means the light that strikes the surface is diffused and is not glancing or parallel to that surface. Slight variations in the colour and finish of materials do not always constitute a defect”.

It is recommended that illumination for inspections be provided to imitate as closely as possible the expected conditions that will be in place at completion.

### Consideration to minimise glancing light

**FIGURE 5.01** What is glancing light

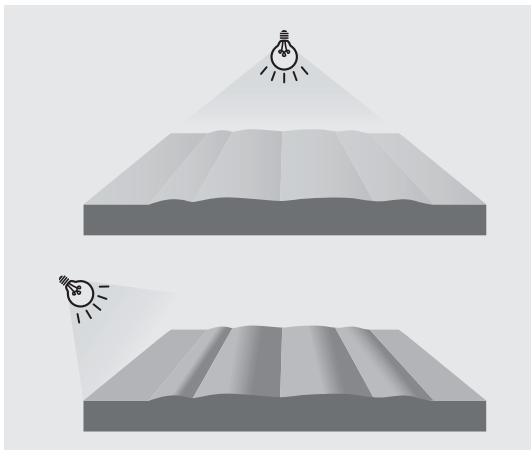

**FIGURE 5.02** Joint orientation

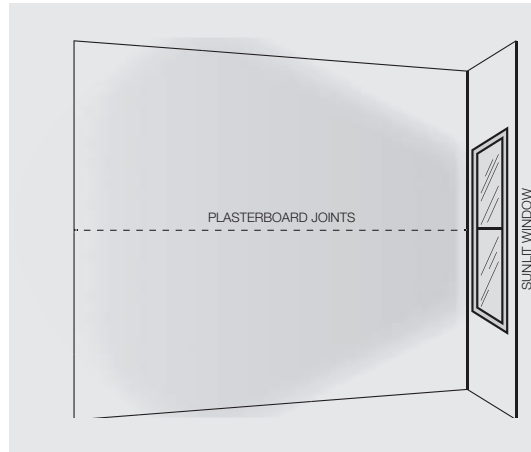

**FIGURE 5.03** Inspection of wallboard

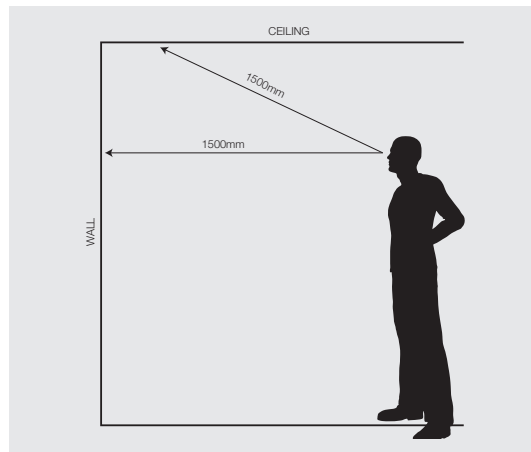

### Framing

Steel framing shall be designed in accordance with AS/NZS 4600. Wallboard may be fixed to steel wall framing of up to 1.5mm in thickness. Brick or block masonry surfaces, and walls of concrete or AAC should have a steel furring channel system applied and fixed in accordance with the appropriate Cemintel system.

Cemintel recommends contact Rondo Building Services Pty Ltd for design advice on the steel framing design to resist the imposed wind and seismic loads. Generally internal non-loadbearing wall studs are friction fitted into tracks with no clearance at the bottom and an allowance for vertical differential framing movement at the top. Where vertical building movement is expected, a suitable gap must be specified. In this case deflection head tracks must be used.

## 05

## DESIGN + AESTHETIC CONSIDERATIONS

Wall tracks must be fixed to floors and ceilings at 600mm maximum centres. Each plate fixing is required to resist seismic loads, wind pressure and all other applicable loads. When fixing to concrete or masonry, use the appropriate power driven fasteners. For walls subject to seismic loads, fasteners shall comply with AS 5216.

Ensure that all framing members to receive sheeting are plumb and true, and that studs or furring channels are spaced at 600mm maximum centres.

### Nogging

Nogging may be required to increase the strength of a stud. The recommended components to be used as nogging are Rondo Nogging Track, Rondo FAST-FIX nogging, and Rondo SNAPLOCK nogging.

Nogging is required for structural purposes in non-load bearing walls and for load bearing walls refer to the project engineer or Rondo for nogging. For horizontal sheet and back blocking installations, the nogging will be positioned away from the horizontal joint.

Where nogging track is used, it should be screw fixed or crimped to both flanges of each stud unless noted. Rondo FAST-FIX noggings should be installed with 2 screws to the face and one screw in the web tab.

Nogging track must not be installed in staggered stud or Quiet Stud wall systems, as additional connection between studs reduces the acoustic performance of these wall systems.

### Wind Loads

All wall framing must be designed for the applied loads. Wind pressures occur on interior wall linings due to air flow through façade elements. Other wind

pressures may be applicable, and the designer should refer to AS/NZS 1170 (series).

Tall residential buildings often have exterior operable doors and windows, resulting in internal walls being subject to wind pressure. In these cases, walls must be designed for the appropriate loads.

Table 5.01 provides the maximum stud spacing for various design wind pressures. For 12mm Wallboard, framing spacing and sizes for 9mm Wallboard can be used.

### Seismic Loads

Seismic actions must be considered for building elements in accordance with the NCC. The loads and effects of earthquakes may be determined in accordance with AS 1170.4 'Structural design actions Earthquake actions in Australia'. The Standard has design procedures for houses with a roof height over 8.5m and to buildings with Importance Levels 2, 3 or 4 as defined in the NCC.

Framed walls lined with fibre cement products are subject to inertial forces and the effect of movement such as inter-storey drift. The calculated seismic forces may be equated to pressures as is done for wind loads and are resisted by the lining product's strength properties and by the fastening methods that attach them to the framing.

Design ultimate capacity pressures for linings are given in Tables 5.01. Values for the design of framing elements may be calculated by standard engineering practices or may be provided by product manufacturers. The effects of both building movement and the inertial forces require specific design of the connection of wall and ceiling framing to the structure. This should be considered as part of the wall structural design and information may be available from the frame supplier.

**TABLE 5.01** Maximum Ultimate Limit State Wind Load (kPa)

	Maximum Ultimate Limit State Wind Load (kPa)			
	0.50	1.00	1.50	2.00
6mm Wallboard No Tiles*	600	450	300	300
6mm Wallboard Tiles#	450	300	300	n/a
9mm Wallboard No Tiles*	600	600	450	450
9mm Wallboard Tiles#	600	600	450	450

\* span/200 deflection limit for walls with 'No tiles'

# span/360 deflection limit for wall with 'Tiles'

## DESIGN + AESTHETIC CONSIDERATIONS



### Control Joints

Movement and stresses created by temperature and humidity changes can result in deformation and damage to internal linings and partitions. It is recommended that framed walls be isolated from other elements using control joints where:

- A lined wall abuts any structural element or dissimilar wall assembly.
- The framing or structural support changes within the wall.
- At all building control joints.
- For non-tiled walls at 6m maximum centres.
- For tiled walls at 4.8m maximum centres and at internal corners.
- At junctions with other building elements.
- At changes of lining material.
- At each storey or rise of studs.

Control joints are incorporated in a building to permit movement in the structure and must be carried through all areas lined with Wallboard. Allowance for movement must be made through the frame, lining, and any tiles. Door frames extending from floor to ceiling constitute control joints. For doors less than ceiling height, a control joint extending from one corner of the frame may be used. Vertical control joints in stud framed walls are to be constructed using two studs with a 15-20mm gap between.

Refer to 'Construction Details - General Areas' for appropriate details.

### Fixtures

Light weight fixtures such as picture frames may be attached to walls with proprietary fixings. Check with the fixing manufacturer for allowable loadings. Heavier loads such as shelves, basins and appliances must be fixed through the linings to the studs.

### Tiling

All tiling must be installed in accordance with the requirements of AS 3958 Part 1. Additional information on tiling may be obtained from the BRANZ publication 'Good Tiling Practice'. Where a waterproof membrane is used, ceramic tiles are recommended. A tile adhesive that is compatible with the membrane and that complies with AS 4992 - 'Ceramic Tiles - grouts and adhesives', must be used. For appropriate tile weights, CSR recommends the use of flexible style adhesives and tile grouts to assistance in relieve imposed tensile stress in the tiles due to differential movement.

### Maintenance

Regular checks of the lining system (at least annually), as well as regular cleaning and re-painting to manufacturer's requirements is recommended to ensure they continue to perform the function which they were intended.

Cemintel Wallboard affected by smoke or fire damage is recommended to be replaced. Minor impact damage to Wallboard resulting in small holes and cracks must be patched, set and finished as originally carried out. Where the Wallboard has suffered significant impact damage, resulting in large holes or cracks, the Wallboard should be repaired using standard methods. In tiled areas any cracks or damaged areas which would allow water ingress into the wall cavity, must be repaired immediately by re-setting and repainting, or by replacing tiles, pointing or sealants. Damaged sheets are not covered by CSR's product warranty and should be replaced.

# 06

COMPONENTS + ACCESSORIES

## COMPONENTS + ACCESSORIES







Note: Codes can change from time to time. Refer to the website for the current list of components prior to ordering.

CeminSeal® Wallboard is available in three thicknesses and has the two long edges recessed (RE) to allow seamless jointing. Some products are available with a Square Edge (SE) finish.

Thickness (mm)	Long Edge Finish	Width (mm)	Length (mm)	Mass (Nominal)	Product code	
					RE	SE
6	RE	900	3000	9.4kg/m <sup>2</sup>	95826	
6	RE	1200	1800	9.4kg/m <sup>2</sup>	95827	
6	RE, SE	1200	2400	9.4kg/m <sup>2</sup>	95828	95850
6	RE, SE	1200	2700	9.4kg/m <sup>2</sup>	95829	95851
6	RE, SE	1200	3000	9.4kg/m <sup>2</sup>	95830	95852
6	RE, SE	1200	3600	9.4kg/m <sup>2</sup>	95841	95861
6	RE	1200	4200	9.4kg/m <sup>2</sup>	95842	
6	RE	1350	2400	9.4kg/m <sup>2</sup>	95843	
6	RE	1350	3000	9.4kg/m <sup>2</sup>	95844	
6	RE	1350	3600	9.4kg/m <sup>2</sup>	95845	
6	RE	1350	4200	9.4kg/m <sup>2</sup>	95846	
9	RE	1200	2400	14.5kg/m <sup>2</sup>	95847	
9	RE, SE	1200	2700	14.5kg/m <sup>2</sup>	95848	95862
9	RE, SE	1200	3000	14.5kg/m <sup>2</sup>	95849	95863
12	RE	1200	3000	18.8kg/m <sup>2</sup>	95825	

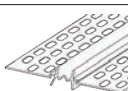
## Accessories

Description	Size/Colour	Qty	Product Code
 <b>Buildex Fibre Teks self-embedding CSK Rib head, Phillips drive, Climaseal 4 finish.</b> For steel BMT 0.5mm min	10-18x25mm	1000 loose	125651
	10-18x30mm	1000 loose	125614
 <b>Gyprock Wet Area Acrylic Sealant</b> Used to seal the edge of the Wallboard against other surfaces such as a preformed shower base or bath and around plumbing fixtures.	450g/300ml	1	10902
<b>Waterproof Membrane.</b> A proprietary impervious barrier assessed and classified in accordance with AS/NZS 4858			By others
<b>Bond breaker.</b> Tape used at wall to floor junctions and movement joints and compatible with the proprietary membrane.			By others
<b>External Vertical Flashing Angle.</b> Zinc coated steel or PVC angle. For use in corners and with external shower trays.			By others
<b>Internal Vertical Flashing.</b> A liquid applied membrane assessed and classified in accordance with AS/NZS 4858, for use with internal shower trays			By others
<b>Perimeter Flashing Angle.</b> Zinc coated steel or PVC angle 75 x 50mm.			By others
 <b>Gyprock™ Acrylic Stud Adhesive.</b> Coloured blue and used in temperatures not less than 5°C.	900g sausage	1	95082
	1kg bucket	1	10090
	5.5kg bucket	1	10091
<b>Perimeter Flashing for Step-Down Slab.</b> Hypalon Flashing Strip 130mm width.			By others
 <b>Hideaway W Expansion Joint</b>	9 x 3000mm	1	10351
 <b>Backing rod</b>	10mm x 50m	1	11177
 <b>Cemintel® Power Saw Blade</b>	1.5mm x 125mm	1	134449



## COMPONENTS + ACCESSORIES

Note: Codes can change from time to time. Refer to the website for the current list of components prior to ordering.

### Steel Framing

CSR Gyprock recommends steel components manufactured by Rondo Building Services Pty Ltd. Additional information on steel building components can be obtained from Rondo.

Other steel components of equivalent performance may be used, however it is the responsibility of the manufacturer of the steel component to substantiate equivalent performance to the recommended component.

### Steel Studs

Rondo Steel Studs are manufactured with 25mm diameter holes at regular spacings along the web to allow electrical/ plumbing services to be easily installed through framing. Service holes in adjacent studs should be aligned at the time of frame assembly.

Studs of 0.50, 0.55 and 0.75mm BMT have bell-mouthed service holes which have no protruding sharp edges, thereby eliminating the need to fit grommets to protect electrical installations.

Studs of 1.15mm BMT have punched service holes at regular spacings along the web.

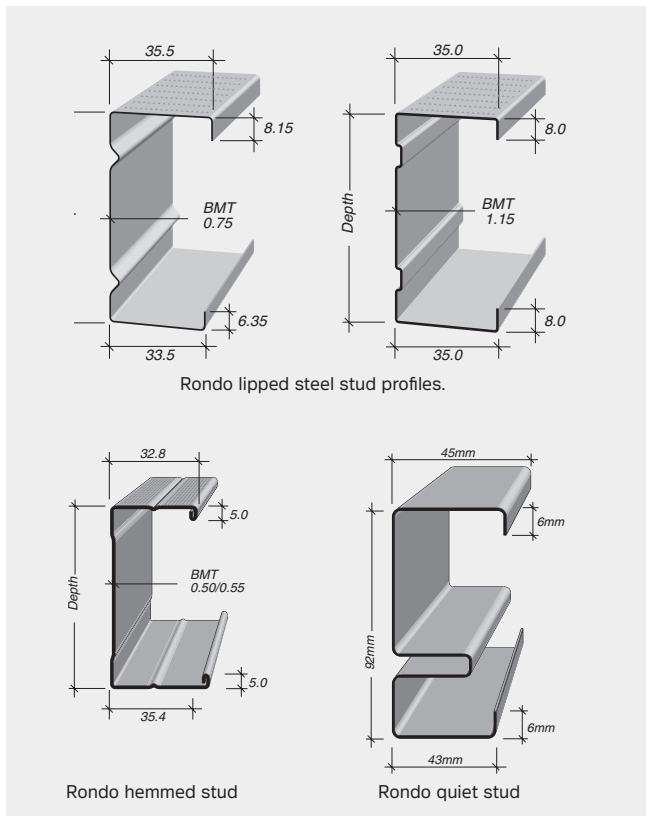

### Wall Track

Rondo Wall Track is used at the top and bottom of wall frames to locate the wall studs. Studs are held in the track by friction fit to allow for movement in the structure.

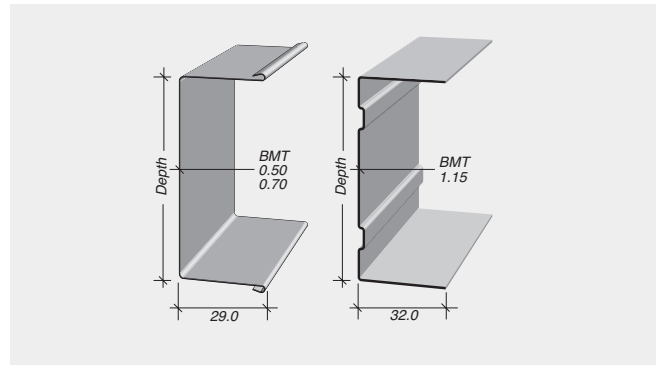

### Deflection Head Track

Rondo Deflection Track is used at the top of wall frames to locate the wall studs and to allow for vertical deflection of the ceiling/soffit. Studs are held in the track by friction and must not be fixed to the deflection track in any way. Wallboard must not be fixed through the track.

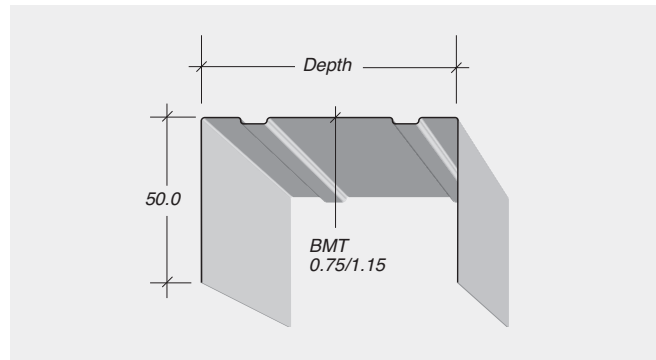

### Slotted Deflection Head Track

Rondo slotted deflection head track is used at the top of wall frames to locate the wall studs and to allow for vertical building movement. A screw connection at each side provides a positive connection to the stud and removes the requirement for an extra noggling near the top track used in some systems.

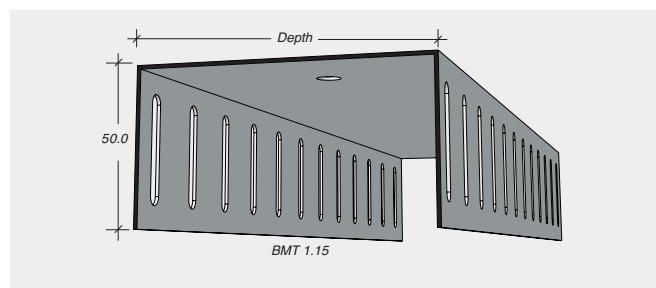



## COMPONENTS + ACCESSORIES



Note: Codes can change from time to time. Refer to the website for the current list of components prior to ordering.

### Rondo Nogging Track

Rondo Nogging Track is designed to support the wall studs and prevent twisting of the studs. Factory punched holes in the web allow quick installation to the studs. Nogging track is an alternative to conventional cut noggings. When fitted, nogging track should be screw fixed or crimped to both flanges of each stud unless noted otherwise.

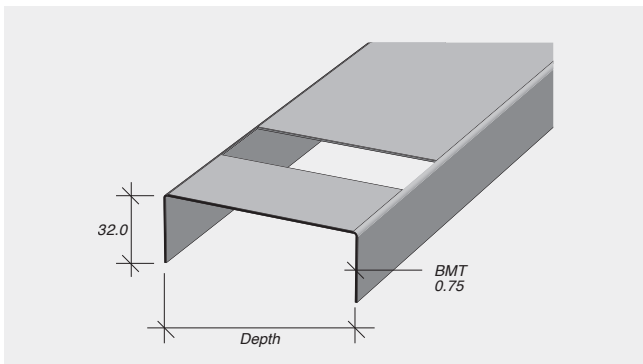

### Rondo FAST-FIX Nogging

Used on one side of studs. Available to suit 300, 400, 450 and 600mm stud centres. Fixed with 2 face screws and one web screw in most applications.

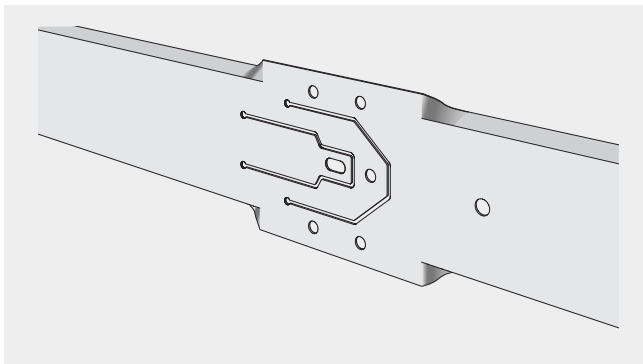

### Rondo SNAP-LOCK Nogging

Used in the bell-mouthed service holes of 0.5 and 0.55mm BMT studs. Available to suit 300, 400, 450 and 600mm stud centres.

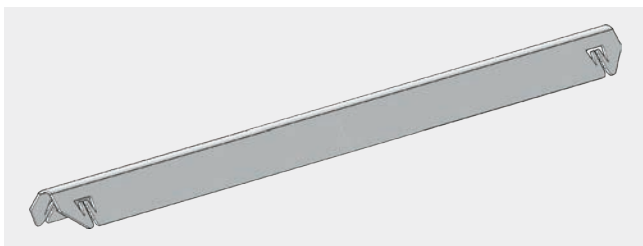

### Gyprock Staggered Stud Clip

For use at top and bottom tracks.

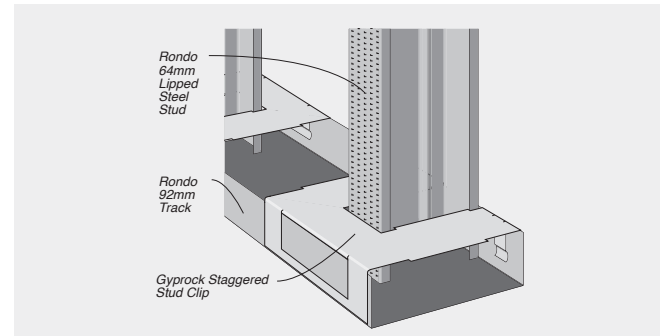

### Rondo 501 Continuous Nogging Bracket

Supplied in 2400mm lengths for on-site cutting to length.

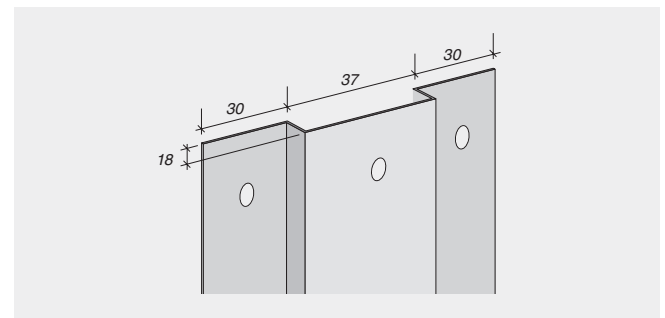

### Rondo 129/308 Furring Channel

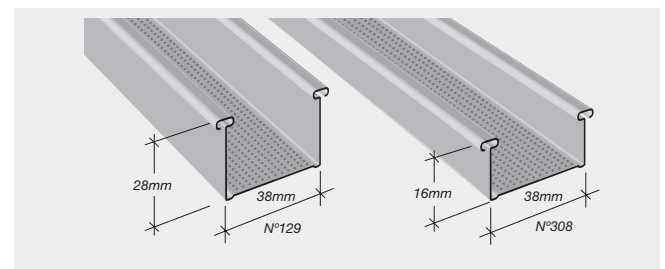

### Furring Channel Track (J-Track)

Used at head and base of walls incorporating furring channels.

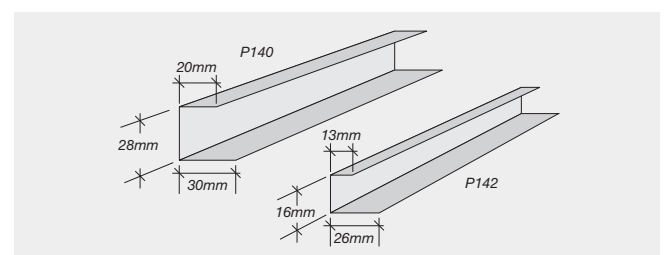



# 07

SYSTEM ENGINEERING

## SYSTEM ENGINEERING



### Design, Detailing And Performance Responsibilities

Cemintel engages independent testing laboratories to test and report on the performance of a wall in accordance with the relevant Australian Standards. Consultants use these reports as the basis for opinions (estimates of laboratory performance) they issue for variations or different arrangements to the tested system. Using their experience, the consultant will make judgement about on-site installed performance of various walls.

#### Project Consultants (Structural, Fire, Acoustic, Etc.)

These consultants are typically responsible for the following:

- Opinions on expected laboratory performance of wall configurations that vary from actual test configuration, such as substitution of products and components;
- Judgements about expected field performance using laboratory test reports and practical experience;
- Design, specification and certification of structural, fire, acoustic, durability, weather tightness and any other required performance criteria for individual projects.

The design and selection of building elements, such as wall and floors and their integration into the building considering the following:

- Interface of different building elements including the structure/substrate;
- Wall and floor junctions;
- Penetrations;
- Flashing issues;
- Room / building geometry; and
- Acoustic and water penetration field-testing.

#### Design Responsibility

Cladding, air barrier, battens and top hats, and structural framing are required to resist wind and earthquake loads that are specific to the building and the site. Additional 'local pressure factors' can apply to cladding and the supporting battens and top hats in accordance with the Australian Standard AS 4055 - Wind loads for housing or AS/NZS 1170.2 – Wind actions. It is recommended that the Architect/Building Designer assigns the responsibility for the façade design to the Project Engineer. Once loads have been determined, the battens and top hat spans, fastener spacing, air barrier construction details, and cladding fixing details may be selected from the appropriate tables in this guide and in the 'Cemintel Facades & Cladding Design Guide'. It is also the responsibility of the Architect / Building Designer to select the appropriate corrosivity category. Refer to appropriate details in this guide.

The performance levels of walls documented in this guide the 'Cemintel Facades & Cladding Design Guide' and CSR Gyprock® The Red Book™ publications are either what is reported in a test or the documented opinion of consultants.

#### Performance in projects is typically the responsibility of:

Project Certifier and/or Builder These professionals are typically responsible for:

- Identifying the performance requirements for the project in accordance with the NCC and clearly communicating this to the relevant parties; and
- Applicability of any performance characteristics supplied by Cemintel including test and opinions for the project.

Cemintel does not provide consulting services. Cemintel provides technical information that has been prepared in consultation with third party subject expert consultants for the presentation of information presented in this guide. This guide may be subject to amendment or change as required or as deemed necessary. The most up to date version of this guide should be referred to and shall be available at the Cemintel website [cemintel.com.au](http://cemintel.com.au).

Any party using the information contained in this guide or supplied by Cemintel in the course of a project must satisfy themselves that it is true, current and appropriate for the application, consequently accepting responsibility for its use.

It is the responsibility of the building designer, architect, engineer and project consultants to ensure that the information and details in this guide and the performance of the Headland Weatherboard wall system is suitable for the intended project application.

The recommendations in this guide are formulated along the lines of good building practice but are not intended to be an exhaustive statement of all relevant data.

Cemintel is not responsible for the performance of constructed walls, including field performance, and does not interpret or make judgements about performance requirements in the NCC.

**Note:** It is the responsibility of the Project Engineer/ Frame Designer to specify the connection of the structural noggings to the structural framing for any off-stud battens or top hats. It is also the responsibility of the project engineer to calculate the wind loads and earthquake loads for the cladding, air barrier and support framing of the façade on a project.

## Cemintel Wallboard Systems

**FIGURE 7.01** Ceminseal Wallboard Fixing To Stud Framing – Horizontal Sheeting – Adhesive + Fastener Fixing – Non-Tiled Areas

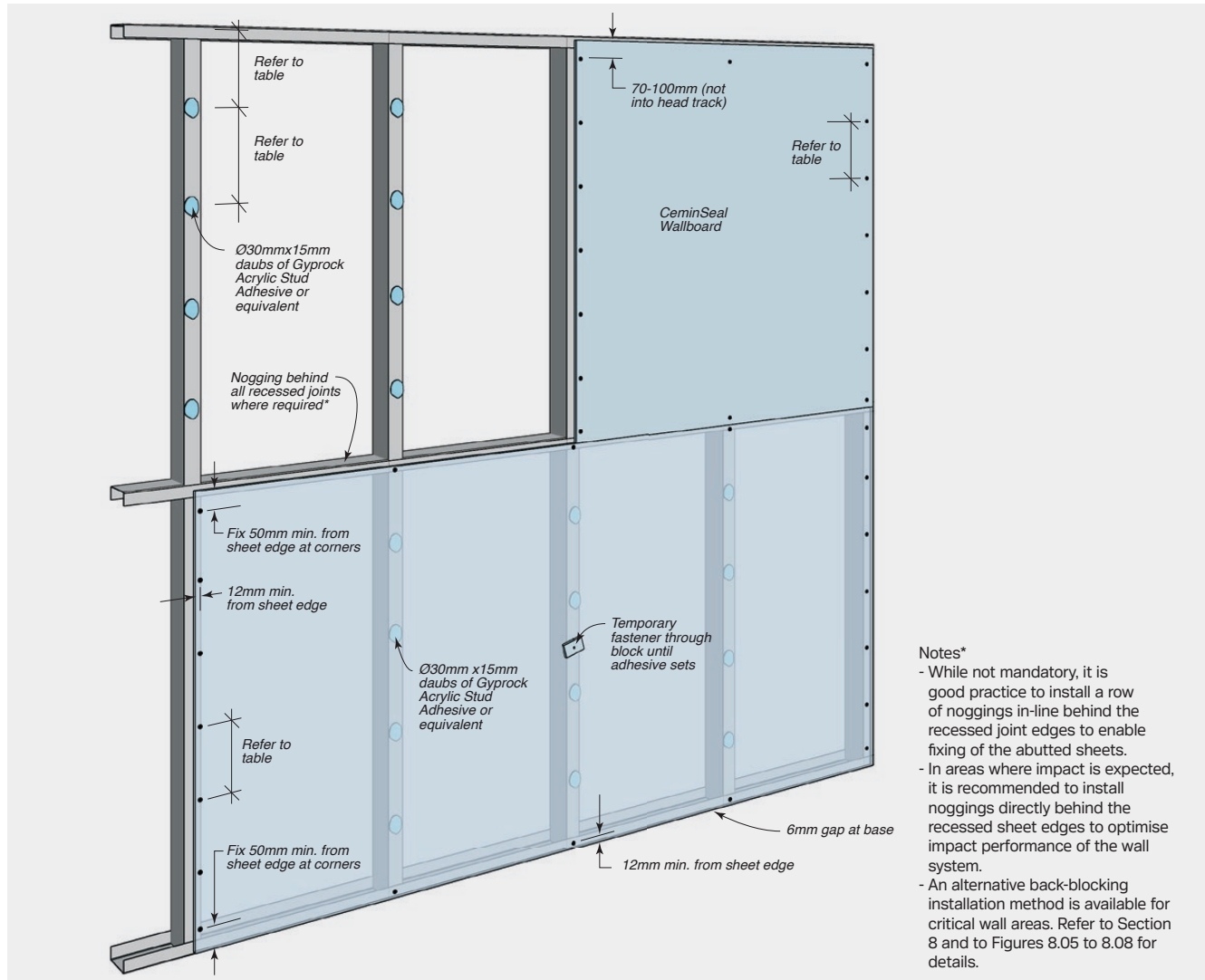

### Jointing and Finishing

Jointing compound selection – refer to section 10 and table 10.01

### Fixing Specifications

Fixing – suitable for up to 1.0 kPa. Framing centres refer to Table 5.01 and Rondo Building Services Pty Ltd..

Screws	Refer to 'Components + Accessories'
<b>Non-Tiled Areas</b>	
Location	Fixing and spacing
Field	Adhesive daubs at 300mm max. centres and 200mm min. from fastener points. Temporary screw fix at every second stud along sheet centreline.
Horizontal edge	Screw at each stud
Vertical joints	200mm max. centres
Corners and openings	300mm max. centres

SYSTEM ENGINEERING



**Cemintel Wallboard Systems**

**FIGURE 7.02** Ceminseal Wallboard Fixing To Stud Framing – Horizontal Sheeting – Fastener Fixing – Non-tiled Or Tiled Areas

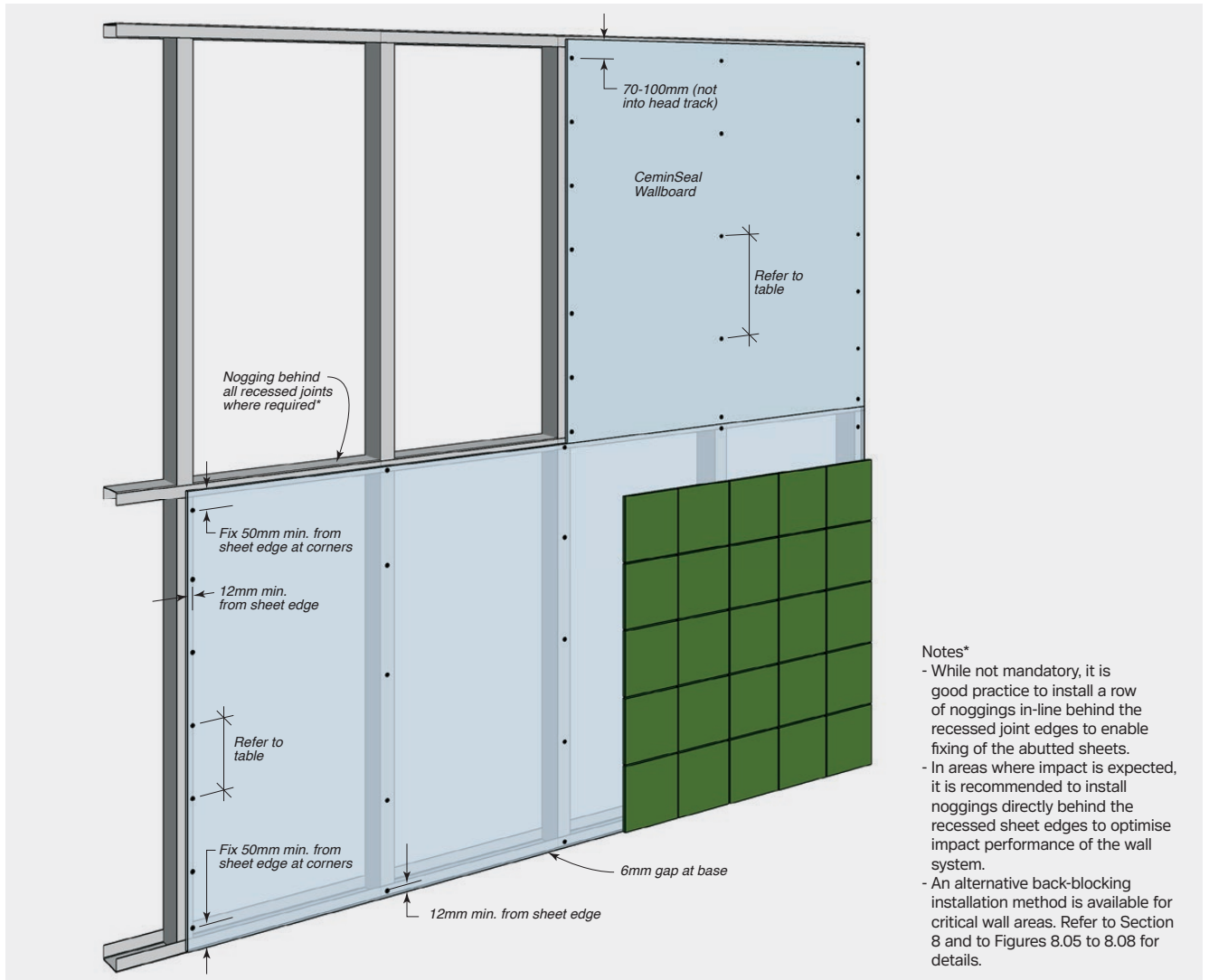

- Notes\*
- While not mandatory, it is good practice to install a row of noggings in-line behind the recessed joint edges to enable fixing of the abutted sheets.
  - In areas where impact is expected, it is recommended to install noggings directly behind the recessed sheet edges to optimise impact performance of the wall system.
  - An alternative back-blocking installation method is available for critical wall areas. Refer to Section 8 and to Figures 8.05 to 8.08 for details.

**Jointing and Finishing**

Jointing compound selection – refer to section 10 and table 10.01

**Fixing Specifications**

Fixing – suitable for up to 1.0 kPa. Framing centres refer to Table 5.01 and Rondo Building Services Pty Ltd..

Screws	Refer to 'Components + Accessories'	<b>Tiled Areas up to 12.5kg/m<sup>2</sup></b>	
<b>Non-Tiled Areas</b>		Location	Fixing and spacing
Location	Fixing and spacing	Field	Screws at 200mm max. centres
Field	Screw at top and bottom and - up to 1.0kPa	Horizontal edges	Screw at each stud
Horizontal edge	300mm max. centres	Vertical joints	200mm max. centres
Vertical joints	Screw at each stud	Corners and openings	200mm max. centres
Corners and openings	200mm max. centres	<b>Tiled Areas up to 32kg/m<sup>2</sup></b>	
	300mm max. centres	Location	Fixing and spacing
		Field	Screws at 100mm max. centres
		Horizontal edges	Screw at each stud
		Vertical joints	100mm max. centres
		Corners and openings	100mm max. centres

## Cemintel Wallboard Systems

**FIGURE 7.03** CeminSeal Wallboard Fixing To Stud Framing – Vertical Sheeting – Fastener Fixing – Non-Tiled Or Tiled Areas

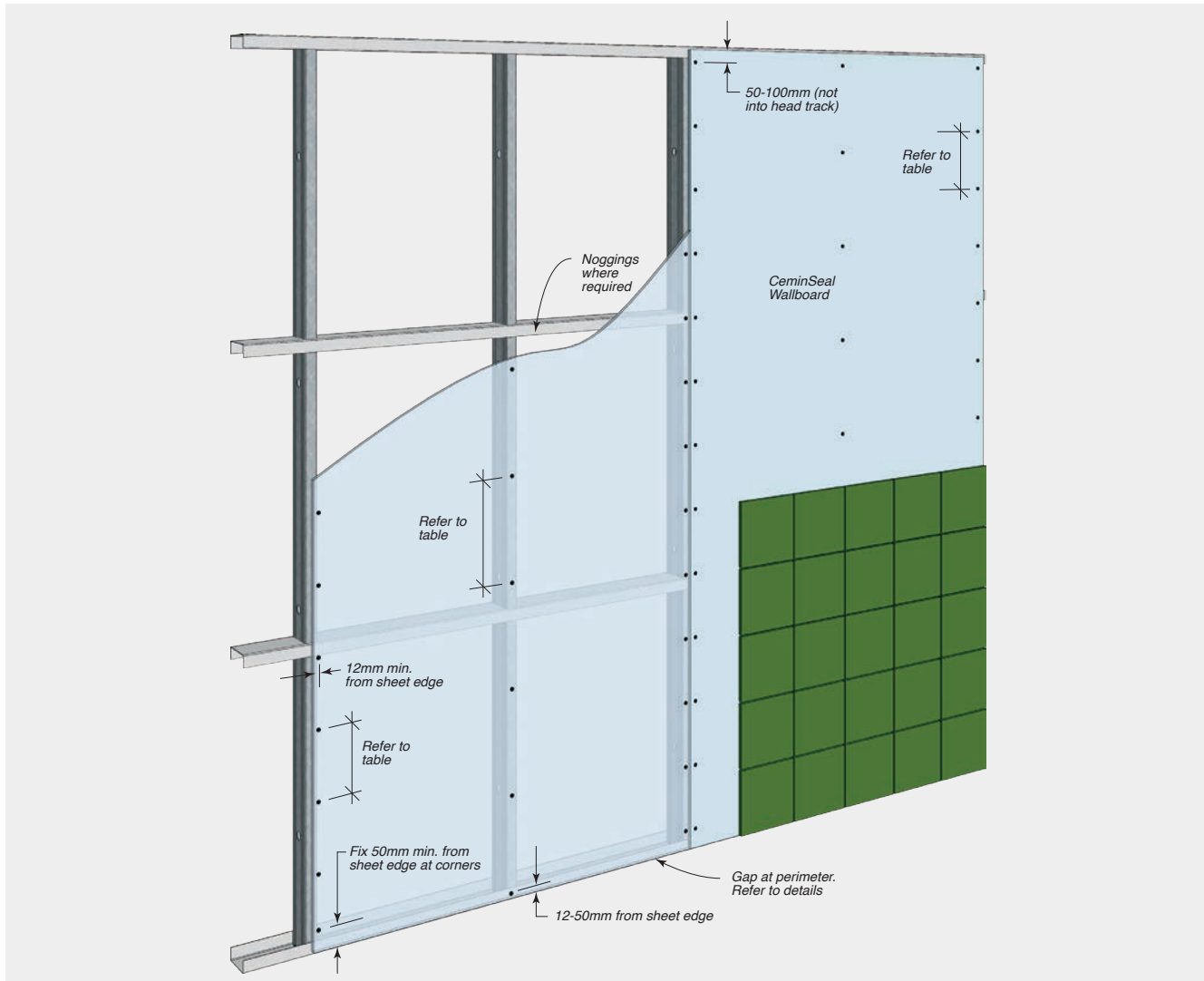

### Jointing and Finishing

Jointing compound selection – refer to section 10 and table 10.01

### Fixing Specifications

Fixing – suitable for up to 1.0 kPa. Framing centres refer to Table 5.01 and Rondo Building Services Pty Ltd..

Screws	Refer to 'Components + Accessories'
<b>Non-Tiled Areas</b>	
Location	Fixing and spacing
Field	Screw at top and bottom and - up to 1.0kPa
Horizontal edge	Screw at each stud
Vertical joints	200mm max. centres
Corners and openings	300mm max. centres

### Tiled Areas up to 12.5kg/m<sup>2</sup>

Location	Fixing and spacing
Field	Screws at 200mm max. centres
Vertical joints	200mm max. centres
Corners and openings	200mm max. centres

### Tiled Areas up to 32kg/m<sup>2</sup>

Location	Fixing and spacing
Field	Screws at 100mm max. centres
Vertical joints	100mm max. centres
Corners and openings	100mm max. centres

## SYSTEM ENGINEERING

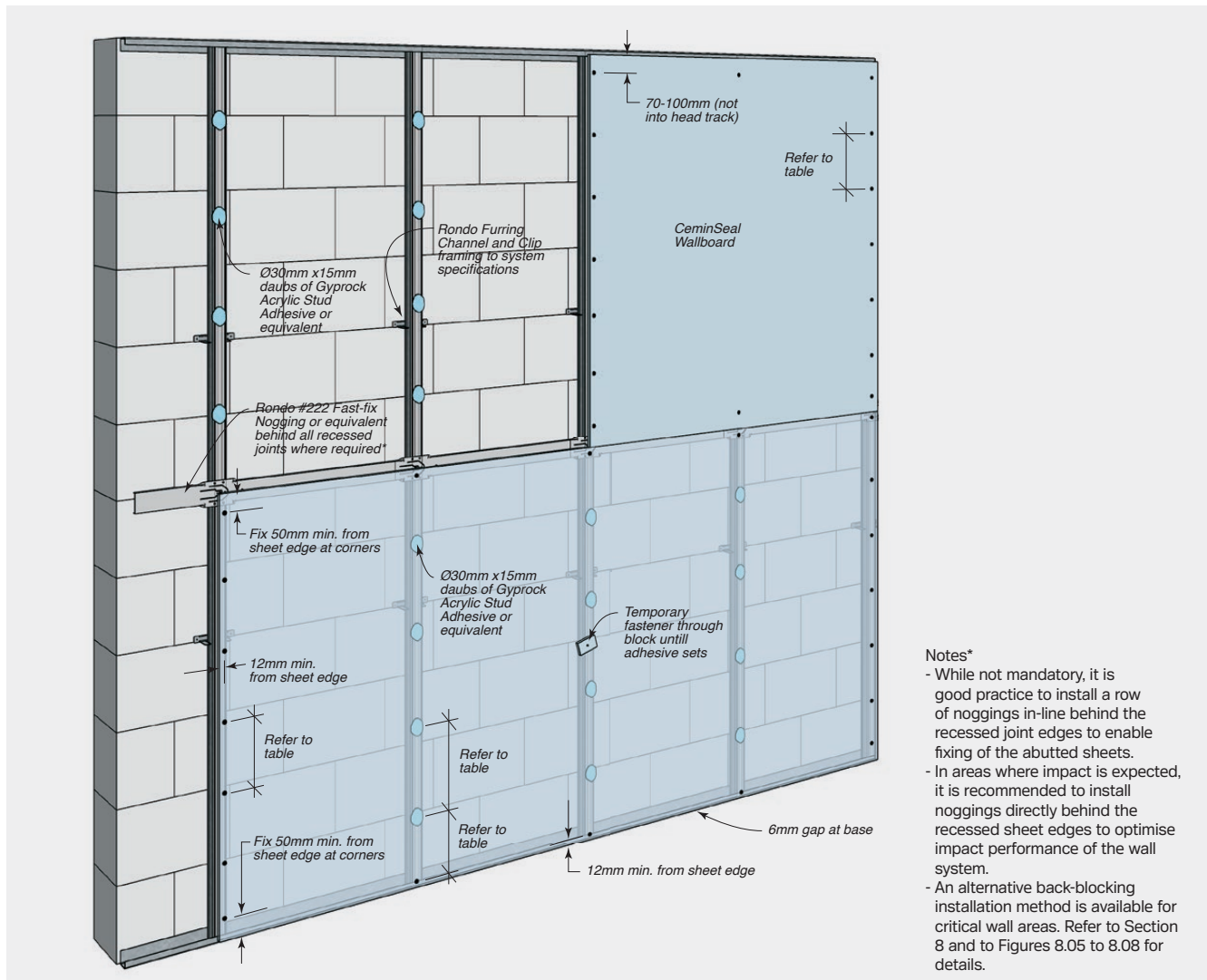

## Cemintel Wallboard Systems

**FIGURE 7.04** Cemintel Wallboard Fixing To Furring Channel Framing – Horizontal Sheeting – Adhesive + Fastener Fixing – Non-Tiled Areas

## Notes\*

- While not mandatory, it is good practice to install a row of noggings in-line behind the recessed joint edges to enable fixing of the abutted sheets.
- In areas where impact is expected, it is recommended to install noggings directly behind the recessed sheet edges to optimise impact performance of the wall system.
- An alternative back-blocking installation method is available for critical wall areas. Refer to Section 8 and to Figures 8.05 to 8.08 for details.

### Jointing and Finishing

Jointing compound selection – refer to section 10 and table 10.01

### Fixing Specifications

Fixing – suitable for up to 1.0 kPa. Framing centres refer to Table 5.01 and Rondo Building Services Pty Ltd..

Screws Refer to 'Components + Accessories'

### Non-Tiled Areas

Location	Fixing and spacing
Field	Adhesive daubs at 300mm max. centres and 200mm min. from fastener points.  Temporary screw fix at every second stud along sheet centreline.
Horizontal edge	Screw at each stud
Vertical joints	200mm max. centres
Corners and openings	300mm max. centres

## Cemintel Wallboard Systems

**FIGURE 7.05** Ceminseal Wallboard Fixing To Furring Channel Framing – Horizontal Sheeting – Fastener Fixing – Non-Tiled Or Tiled Areas

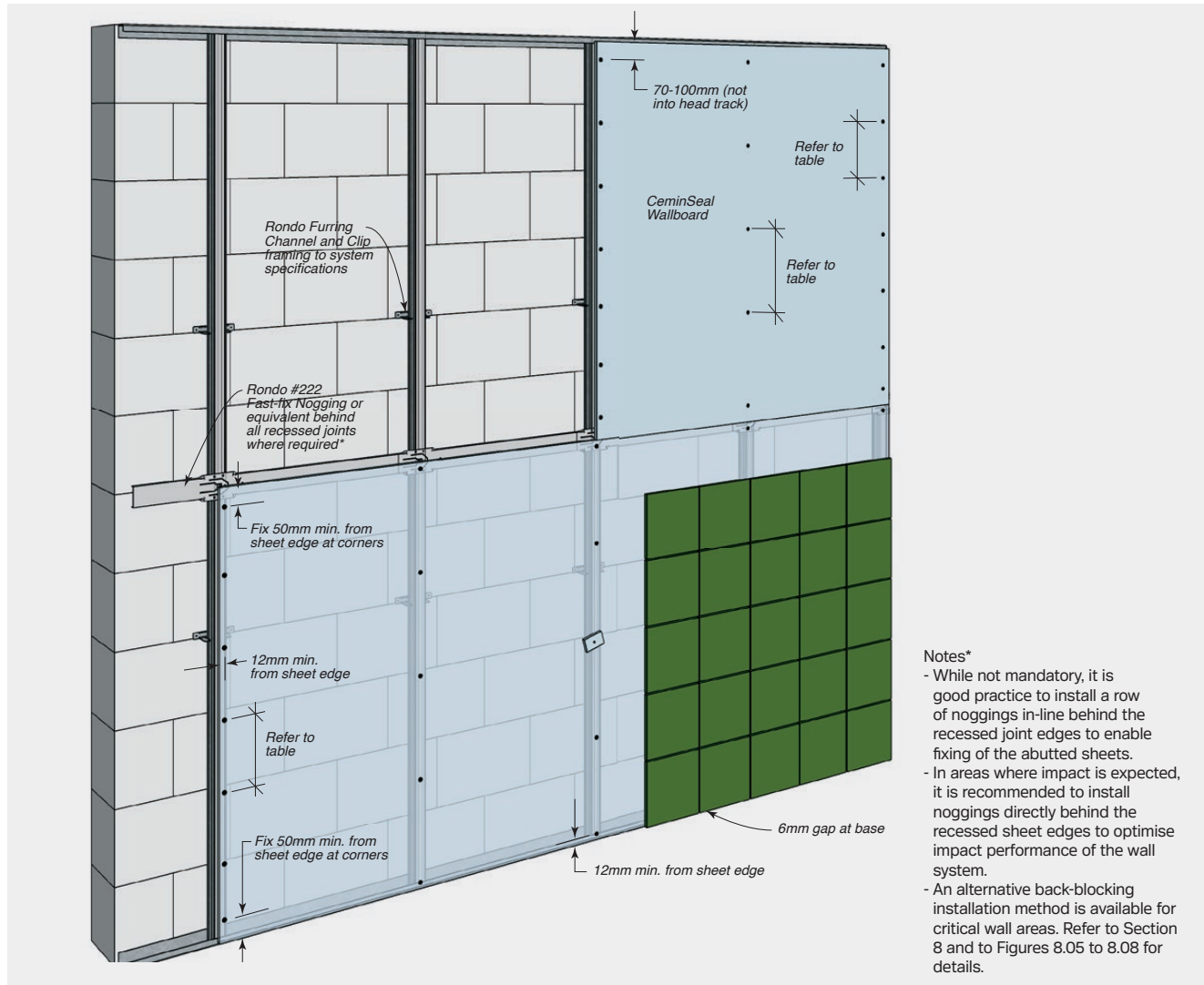

### Jointing and Finishing

Jointing compound selection – refer to section 10 and table 10.01

### Fixing Specifications

Fixing – suitable for up to 1.0 kPa. Framing centres refer to Table 5.01 and Rondo Building Services Pty Ltd..

Screws	Refer to 'Components + Accessories'
<b>Non-Tiled Areas</b>	
Location	Fixing and spacing
Field	Screw at top and bottom and - up to 1.0kPa
Horizontal edge	Screw at each stud
Vertical joints	200mm max. centres
Corners and openings	300mm max. centres

### Tiled Areas up to 12.5kg/m<sup>2</sup>

Location	Fixing and spacing
Field	Screws at 200mm max. centres
Horizontal edges	Screw at each stud
Vertical joints	200mm max. centres
Corners and openings	200mm max. centres

### Tiled Areas up to 32kg/m<sup>2</sup>

Location	Fixing and spacing
Field	Screws at 100mm max. centres
Horizontal edges	Screw at each stud
Vertical joints	100mm max. centres
Corners and openings	100mm max. centres



SYSTEM ENGINEERING



**Cemintel Wallboard Systems**

**FIGURE 7.06** CeminSeal Wallboard Fixing To Furring Channel Framing – Vertical Sheeting – Fastener Fixing – Non-Tiled Or Tiled Areas

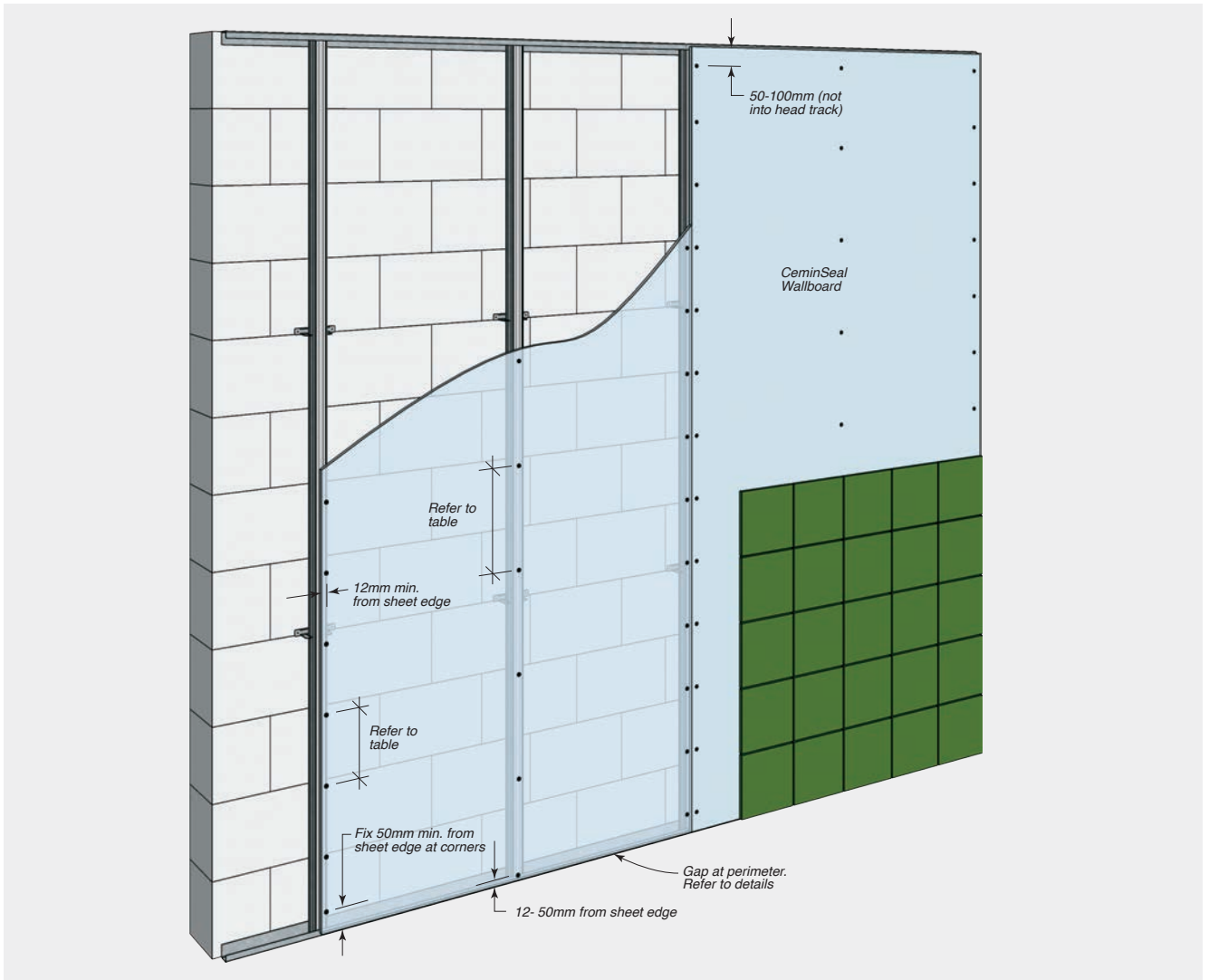

**Jointing and Finishing**

Jointing compound selection – refer to section 10 and table 10.01

**Fixing Specifications**

Fixing – suitable for up to 1.0 kPa. Framing centres refer to Table 5.01 and Rondo Building Services Pty Ltd..

Screws		Refer to 'Components + Accessories'	<b>Tiled Areas up to 12.5kg/m<sup>2</sup></b>	
<b>Non-Tiled Areas</b>			Location	Fixing and spacing
Location	Fixing and spacing		Field	Screws at 200mm max. centres
Field	Screw at top and bottom and - up to 1.0kPa		Vertical joints	200mm max. centres
Horizontal edge	Screw at each stud		Corners and openings	200mm max. centres
Vertical joints	200mm max. centres		<b>Tiled Areas up to 32kg/m<sup>2</sup></b>	
Corners and openings	300mm max. centres		Location	Fixing and spacing
			Field	Screws at 100mm max. centres
			Vertical joints	100mm max. centres
			Corners and openings	100mm max. centres



## INSTALLATION



Cemintel Wallboard sheets may be installed horizontally or vertically. Sheet orientation should be chosen so that any critical light falls along the recessed joints, or to minimise the number of butt joints. In general, for walls with a paint finish, horizontal sheeting should be used, except that a single sheet may be fixed vertically where it covers the whole wall. For walls that are to be finished with tiles, vertical sheeting is recommended, with all sheet joints supported by framing.

## Sheet Preparation

### Cutting

CSR recommends using the Cemintel™ Power Saw Blade for cutting Wallboard sheets. It should be used with circular saws fitted with a vacuum extraction system.

### Cemintel™ Power Saw Blade



### On-Site Recessing

For walls that are to be paint finished, it is recommended that sheet ends and all cut edges have a recess formed to assist with smooth finishing. An angle grinder with vacuum extraction system should be used. The recess should be 1.5mm to 2mm deep and approximately 35mm wide.



Hitachi/HiKOKI Easy Bevel attachment with dust extraction system fitted to a grinder.

### Electrical Wiring

Where electrical wiring is obviously mounted for connection to a wall or ceiling fixture, the installer shall pass the cables through a neat, close-fitting hole in the face of the sheet at the appropriate position clearly marked by the electrician.

## Sheet Fixing

Where possible, sheeting should commence from the end facing the open side of the studs. Refer to FIGURE 4.01.

### Installation Considerations

- Adhesive daubs must never coincide with fastening points.
- Joints are not to coincide with the edge of openings (e.g. doorways, windows, vents etc.) except where they form a control joint. Sheets are to be laid so that any joint falls a minimum of 200mm from the edge of an opening. Avoid butt joints over single doorways and cavity sliding doors wherever possible. Refer to Figure 8.02.
- Where CeminSeal Wallboard is used as a substrate for tiles, the sheets must be fastened with screws only. Adhesive/ fastener fixing is not acceptable.
- Do not fasten sheets to the head tracks in stud wall systems.
- Do not fix sheets to steel framing which is greater than 1.5mm in thickness.
- All vertical joints are to be formed on framing. Horizontal joints are to be back-blocked as detailed.
- In non-tiled areas, sheet ends and cut edges within the field of the wall section are to be machined to form a recess.
- Butt joints in adjacent sheets on the same side of a wall are to be staggered and located on different framing members.
- Ensure that all services and insulation materials are installed (when required), prior to the fixing of sheets to the second side of stud walls.
- External corners subject to damage are to be protected with a suitable corner bead attached and finished as per details in the 'Jointing and Finishing' section of this guide.
- In acoustic rated systems, all outer layer joints and corners, including those in non-visible areas, such as ceiling voids, must be finished with a minimum of base coat and paper tape.
- All fasteners are to be driven home with the head flush with the surface of the sheet. Best results are obtained using a screw gun. Do not overdrive fasteners.



INSTALLATION

**FIGURE 8.01** Sheeting direction and butt joint location

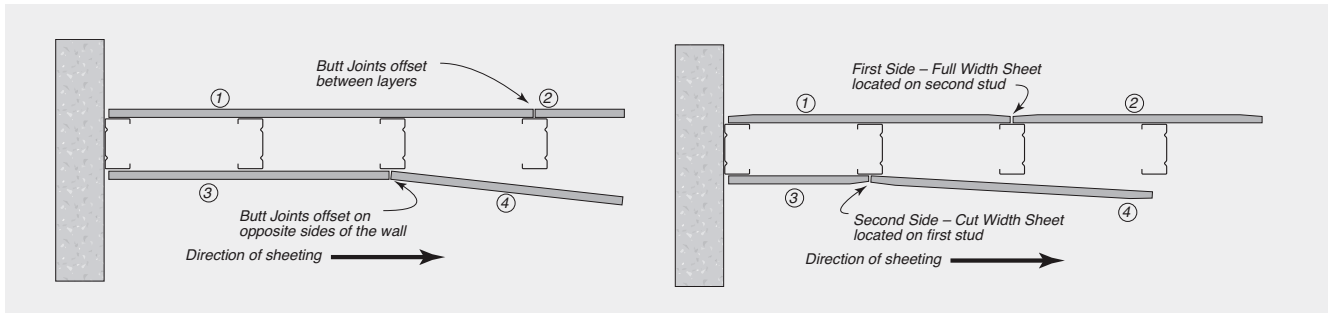

**FIGURE 8.02** CeminSeal wallboard layout

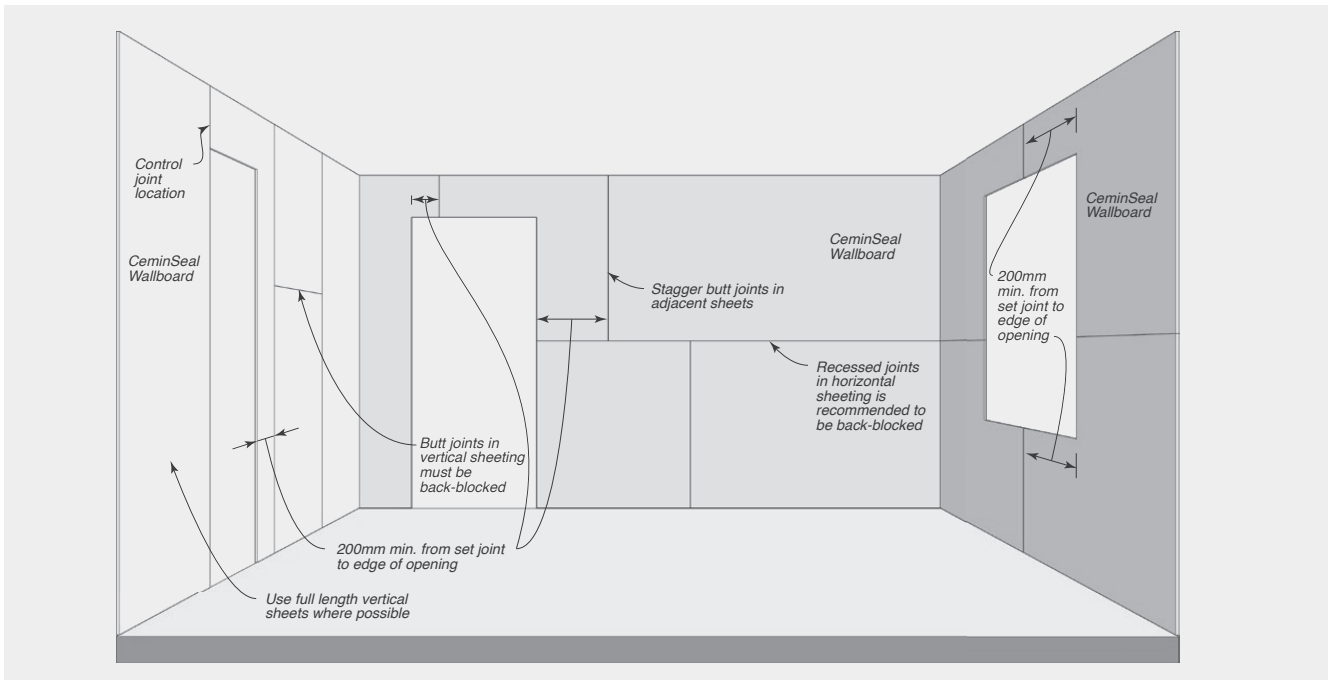

**FIGURE 8.03** Fastener Driving

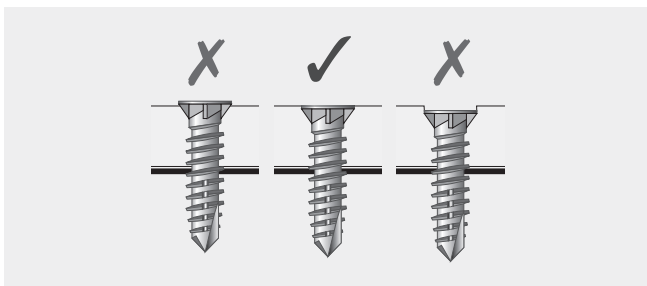

**FIGURE 8.04** Fastener position for recessed joint or butt joint

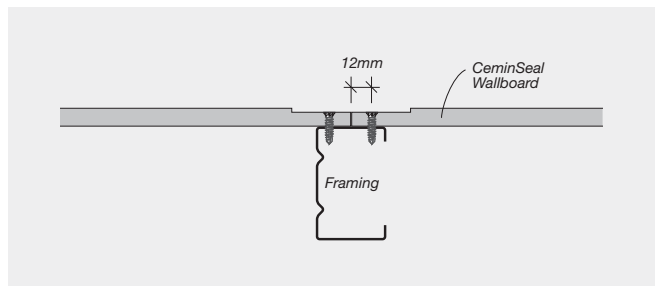

## INSTALLATION



### Back-blocking (Alternative Installation)

For walls that support heavy finishes/tiles, are located in high traffic areas or are subjected to high thermal movement cycles, it is recommended that back-blocking is installed over the horizontal sheet joints to provide a superior joint strength. The back-blocking is comprised of Cemintel Wallboard pieces, 300mm high and 20mm to 30mm from the adjacent studs, bonded centrally behind the horizontal joint with Gyprock Acrylic Stud Adhesive. Fibre-Tek screws shall be used on each side of the joint to ensure an effective bond and the screws may be removed after 24 hours, if required. For an overview of back-blocking installation, refer to Figures 8.05 to 8.08.

Note: to provide adequate space for the installation of the backing blocking, the nogging and other framing should be offset by a minimum of 200mm from the horizontal joint.

### Back-Blocking Installation Procedure

- Install lower Wallboard sheeting to stud frame.
- Apply adhesive to half of the back-blocking piece, using four 5mm beads or a 5mm notched trowel.
- Fix the back-blocking piece to the back of the bottom Wallboard sheet with 2 screws through the edge recess.
- Apply Gyprock stud adhesive on the top half of the back-blocking piece with the same pattern.
- Install the upper horizontal Wallboard to the stud frame.
- Screw the back block piece through the recess edge on the top Wallboard.
- Allow at least 24 hours drying time before setting joints.

The reverse installation procedure may be applied when fixing top sheets first.

### Caulking

Caulk **all perimeter gaps** and penetrations to achieve stated acoustic performance. Use Gyprock Wet Area Acrylic Sealant.

### Jointing & Finishing

Sheets are to be fitted together neatly at joints. Gaps up to 3mm wide must be filled with a Gyprock base coat before jointing.

Refer to the 'Jointing and Finishing' section of this guide for detailed information.



## INSTALLATION

### Cemintel Wallboard Systems

**FIGURE 8.05** CeminSeal Wallboard Fixing To Stud Framing – Horizontal Sheeting With Back-Blocked Joints – Adhesive + Fastener Fixing – Non-Tiled Areas (Alternative Installation)

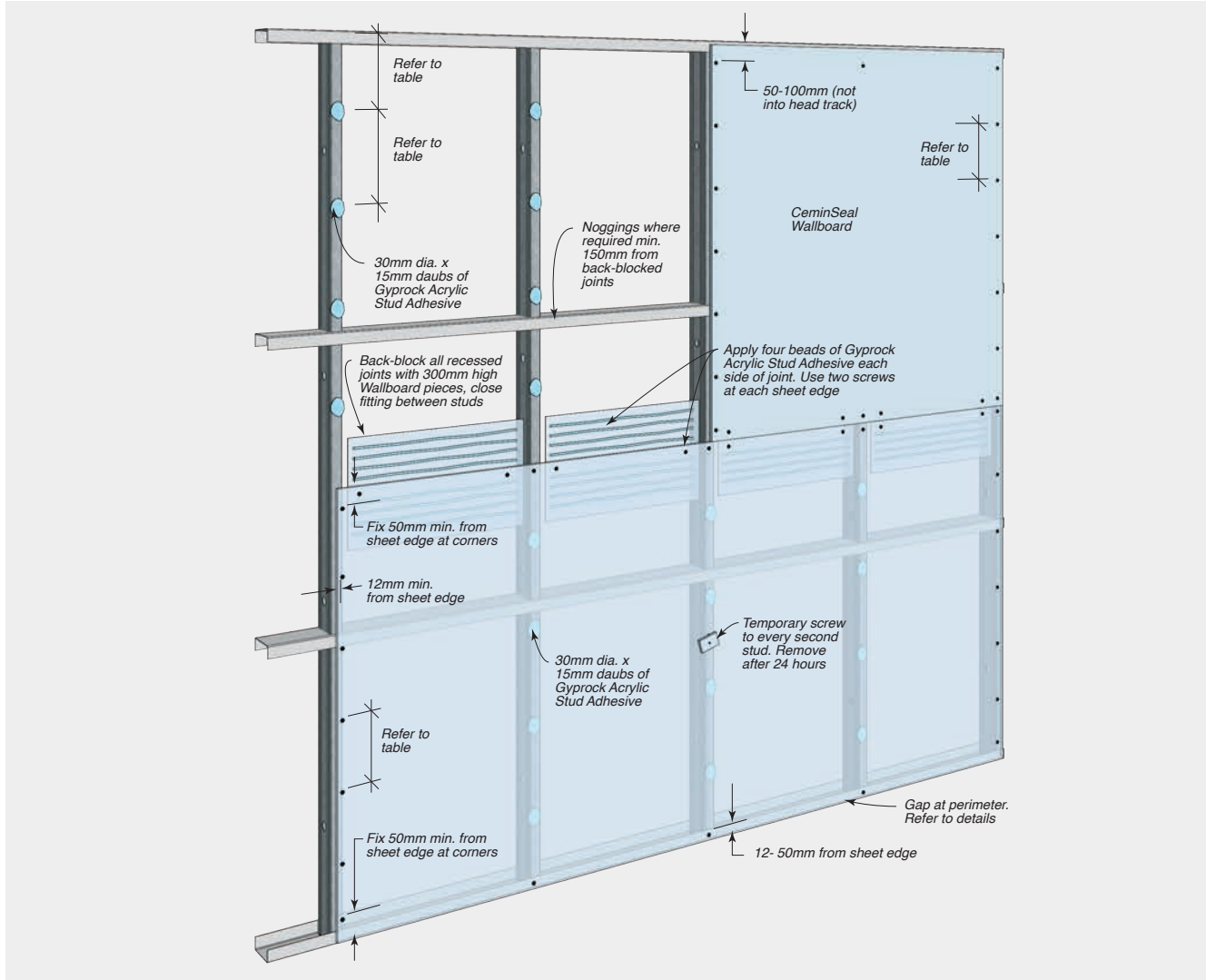

#### Jointing and Finishing

Jointing compound selection – refer to section 10 and table 10.02

#### Fixing Specifications

Fixing – suitable for up to 1.0 kPa. Framing centres refer to Table 5.01 and Rondo Building Services Pty Ltd..

Screws	Refer to 'Components + Accessories'
<b>Non-Tiled Areas</b>	
Location	Fixing and spacing
Field	Adhesive daubs at 300mm max. centres and 200mm min. from fastener points. Temporary screw fix at every second stud along sheet centreline.
Horizontal edge	Screw at each stud
Vertical joints	200mm max. centres
Corners and openings	300mm max. centres

INSTALLATION



**Cemintel Wallboard Systems**

**FIGURE 8.06** CeminSeal Wallboard Fixing To Stud Framing – Horizontal Sheeting With Back-Blocked Joints – Fastener Fixing – Non-Tiled Or Tiled Areas (Alternative Installation)

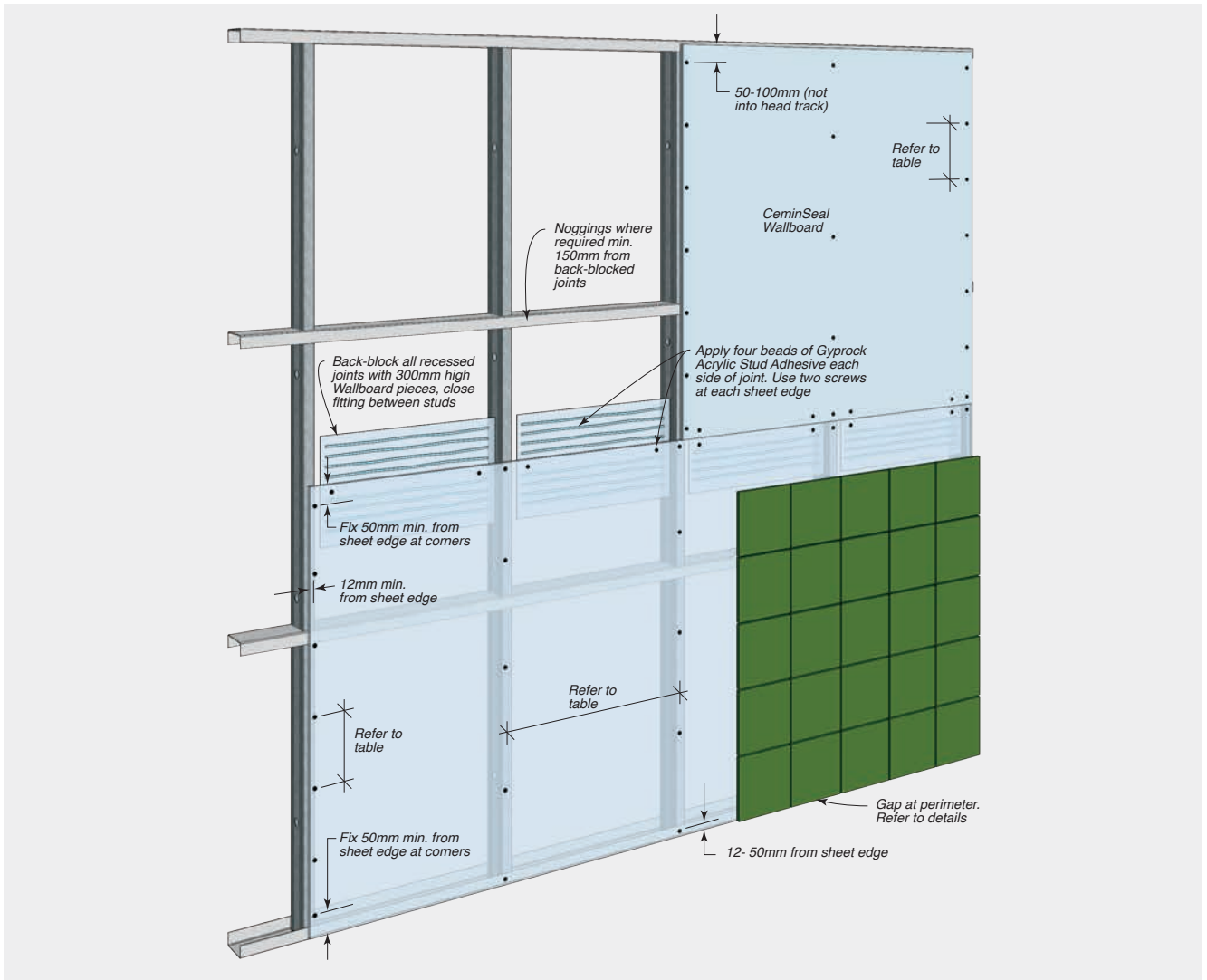

**Jointing and Finishing**

Jointing compound selection – refer to section 10 and table 10.02

**Fixing Specifications**

Fixing – suitable for up to 1.0 kPa. Framing centres refer to Table 5.01 and Rondo Building Services Pty Ltd..

Screws	Refer to 'Components + Accessories'
<b>Non-Tiled Areas</b>	
Location	Fixing and spacing
Field	Screw at top and bottom and - up to 1.0kPa
	300mm max. centres
Horizontal edge	Screw at each stud
Vertical joints	200mm max. centres
Corners and openings	300mm max. centres

**Tiled Areas up to 12.5kg/m<sup>2</sup>**

Location	Fixing and spacing
Field	Screws at 200mm max. centres
Horizontal edges	Screw at each stud
Vertical joints	200mm max. centres
Corners and openings	200mm max. centres

**Tiled Areas up to 32kg/m<sup>2</sup>**

Location	Fixing and spacing
Field	Screws at 100mm max. centres
Horizontal edges	Screw at each stud
Vertical joints	100mm max. centres
Corners and openings	100mm max. centres



## INSTALLATION

### Cemintel Wallboard Systems

**FIGURE 8.07** CeminSeal Wallboard Fixing To Furring Channel Framing – Horizontal Sheeting With Back-Blocked Joints – Adhesive + Fastener Fixing – Non-Tiled Areas (Alternative Installation)

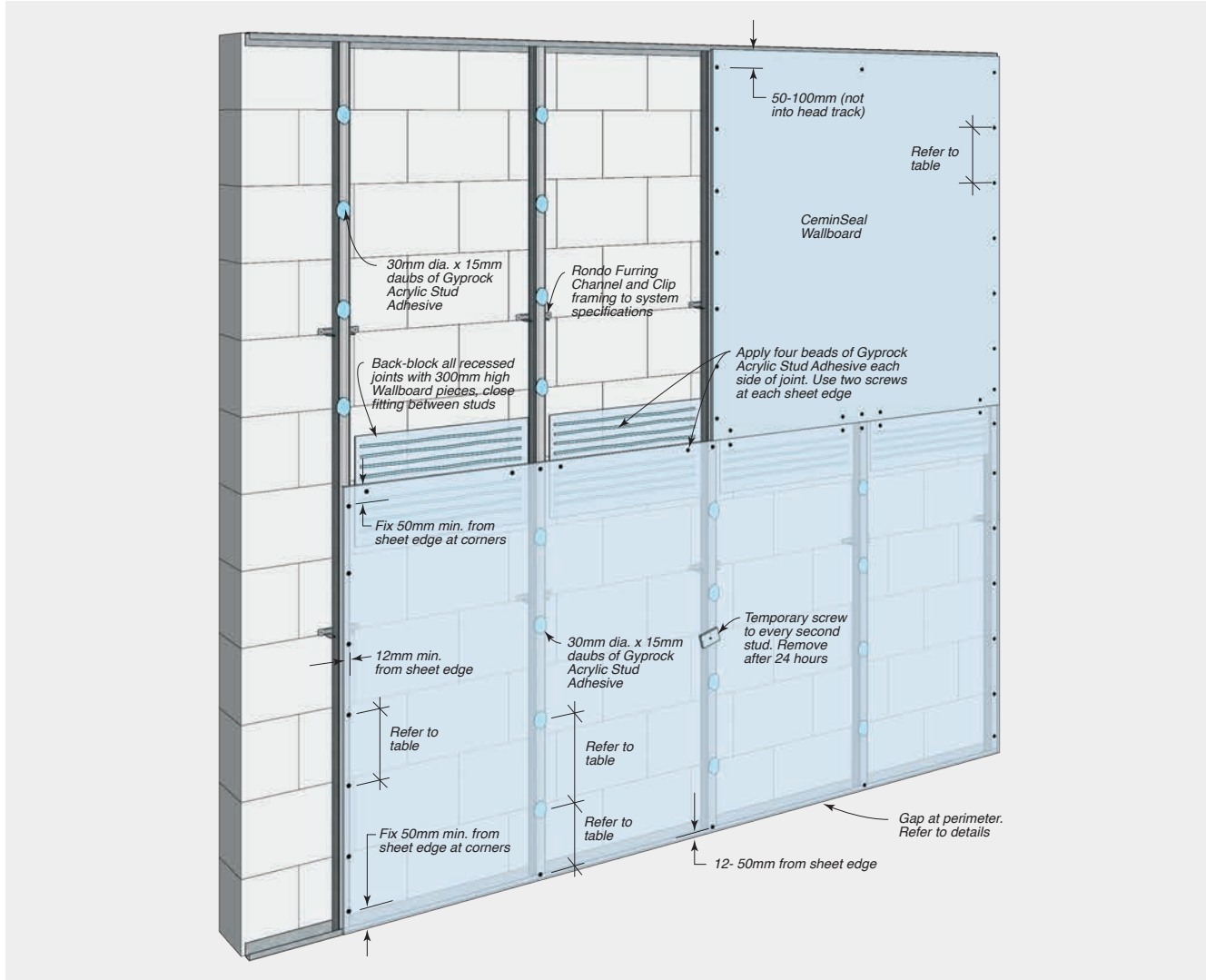

#### Jointing and Finishing

Jointing compound selection – refer to section 10 and table 10.02

#### Fixing Specifications

Fixing – suitable for up to 1.0 kPa. Framing centres refer to Table 5.01 and Rondo Building Services Pty Ltd..

Screws Refer to 'Components + Accessories'

#### Non-Tiled Areas

Location	Fixing and spacing
Field	Adhesive daubs at 300mm max. centres and 200mm min. from fastener points.  Temporary screw fix at every second stud along sheet centreline.
Horizontal edge	Screw at each stud
Vertical joints	200mm max. centres
Corners and openings	300mm max. centres



INSTALLATION



**Cemintel Wallboard Systems**

**FIGURE 8.08** CeminSeal Wallboard Fixing To Furring Channel Framing – Horizontal Sheeting With Back-Blocked Joints – Fastener Fixing – Non-Tiled Or Tiled Areas (Alternative Installation)

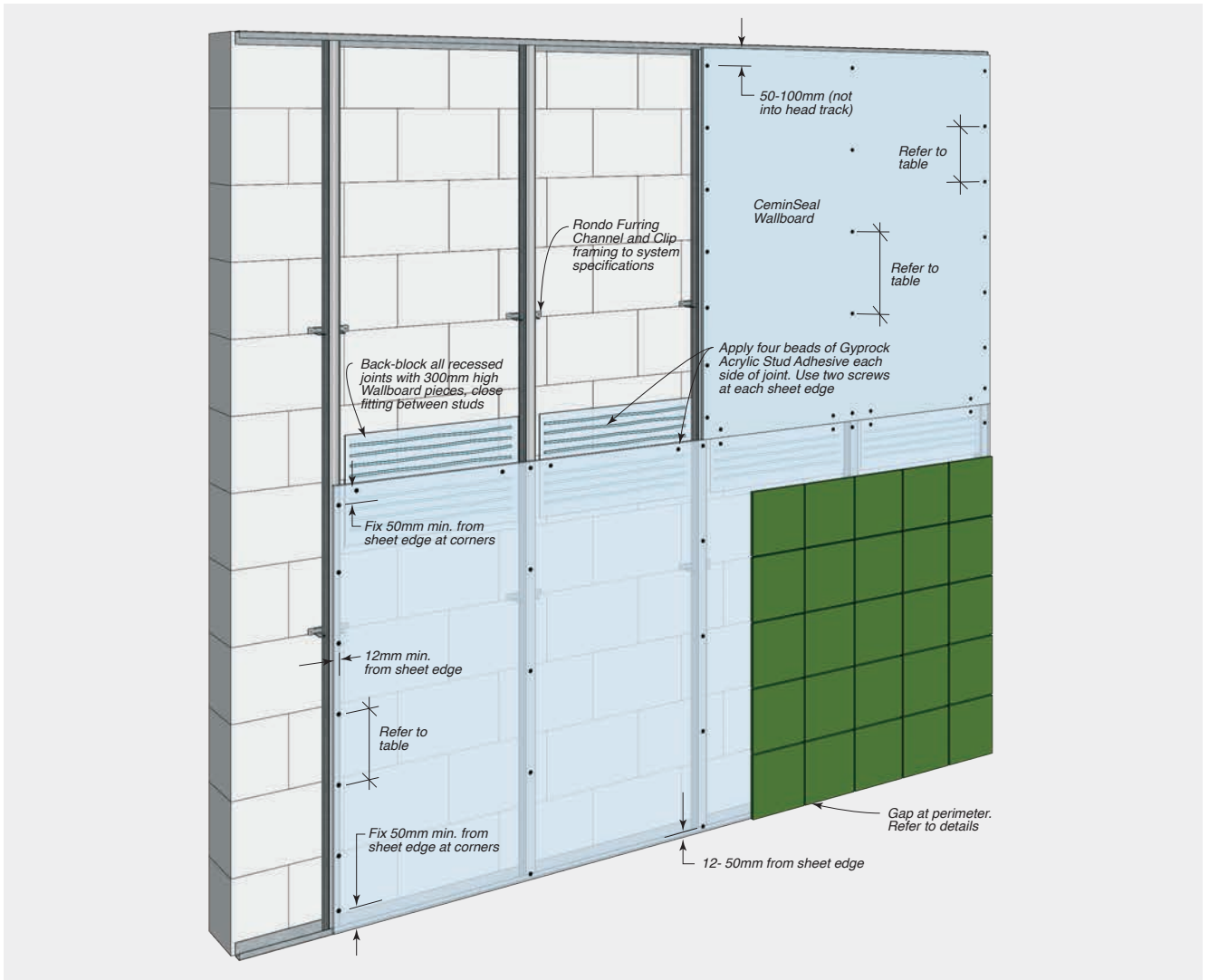

**Jointing and Finishing**

Jointing compound selection – refer to section 10 and table 10.02

**Fixing Specifications**

Fixing – suitable for up to 1.0 kPa. Framing centres refer to Table 5.01 and Rondo Building Services Pty Ltd..

Screws	Refer to 'Components + Accessories'
<b>Non-Tiled Areas</b>	
Location	Fixing and spacing
Field	Screw at top and bottom and - up to 1.0kPa
Horizontal edge	Screw at each stud
Vertical joints	200mm max. centres
Corners and openings	300mm max. centres

**Tiled Areas up to 12.5kg/m<sup>2</sup>**

Location	Fixing and spacing
Field	Screws at 200mm max. centres
Horizontal edges	Screw at each stud
Vertical joints	200mm max. centres
Corners and openings	200mm max. centres

**Tiled Areas up to 32kg/m<sup>2</sup>**

Location	Fixing and spacing
Field	Screws at 100mm max. centres
Horizontal edges	Screw at each stud
Vertical joints	100mm max. centres
Corners and openings	100mm max. centres



# CONSTRUCTION DETAILS

## CONSTRUCTION DETAILS



SECTION	DESCRIPTION	FIGURE REFERENCE	PAGE NUMBER
<b>GENERAL NON-WET AREAS</b>			
<b>JUNCTIONS</b>	FRICION FIT HEAD	9.01	36
	WALL BASE DETAIL	9.02	36
	TEE JUNCTION – NON-TILED WALLS	9.03	36
	TEE JUNCTION – NON-TILED WALLS – ALTERNATIVE	9.04	36
	STUD WALL JUNCTION WITH MASONRY WALL	9.05	37
	<b>CONTROL JOINTS</b>	VERTICAL CONTROL JOINT – STEEL STUD WALL SYSTEM	9.06
	VERTICAL CONTROL JOINT – NON-TILED WALL	9.07	37
	VERTICAL CONTROL JOINT – TILED WALL	9.08	37
<b>SHOWER/BATH WET AREAS</b>			
<b>SHOWER BASE/TRAY/ RECESS</b>	PREFORMED SHOWER BASE INSTALLATION	9.09	39
	PREFORMED SHOWER TRAY INSTALLATION	9.10	39
	TYPICAL DETAIL FOR PREFORMED SHOWER BASE	9.11	39
	TYPICAL DETAIL FOR PREFORMED SHOWER TRAY	9.12	39
	INSITU-FORMED SHOWER MEMBRANE – CLASS II OR III MEMBRANE	9.13	40
	INSITU-FORMED SHOWER MEMBRANE – CLASS III MEMBRANE	9.14	40
	TYPICAL DETAIL FOR INSITU-FORMED SHOWER MEMBRANE	9.15	41
	INSITU-FORMED SHOWER RECESS WITH HOB	9.16	41
	PREFORMED SHOWER BASE	9.17	41
	INSITU-FORMED SHOWER RECESS – CLASS II OR CLASS III MEMBRANE	9.18	41
<b>MEMBRANE DETAIL</b>	MEMBRANE DETAIL FOR A SEMI-ENCLOSED SHOWER OVER BATH OR SHOWER AREA	9.19	42
	MEMBRANE AND TILE DETAIL FOR AN UNENCLOSED SHOWER OVER BATH OR SHOWER AREA	9.20	43
<b>CORNER DETAIL</b>	INTERNAL CORNER DETAIL – CLASS II MEMBRANE	9.21	43
	INTERNAL CORNER DETAIL – CLASS II MEMBRANE	9.22	43
	INTERNAL CORNER DETAIL – CLASS III MEMBRANE	9.23	44
	INTERNAL CORNER DETAIL – CLASS III MEMBRANE	9.24	44
<b>BATH</b>	INSTALLATION LAYOUT FOR A BATH WITHOUT SHOWER	9.25	44
	BATH INSTALLATION TO STUD WALL	9.26	45
	BATH HOB	9.27	45
<b>GENERAL WET AREAS</b>			
<b>HAND BASIN</b>	TYPICAL HAND BASIN – MEMBRANE/TILING DETAIL	9.28	46
<b>LAUNDRY TUB</b>	LAUNDRY TUB/SINK INSTALLATION	9.29	46
<b>PLUMBING PENETRATIONS</b>	PLUMBING PENETRATIONS	9.30	46
<b>PERIMETER ANGLE FLASHING</b>	PERIMETER ANGLE FLASHING	9.31	46
<b>JOINTING AND FINISHING</b>			
	RECESSED EDGE – NON-TILED AREAS	10.01	50
	BUTT JOINT – NON-TILED AREAS	10.02	50
	JOINTING BUTT OR RECESSED EDGE – TILED AREAS	10.03	50
	INTERNAL CORNERS – NON-TILED AREAS	10.04	51
	FINISHING INTERNAL BLOCKED CORNER – TILED AREAS	10.05	51
	FINISHING INTERNAL CORNER – TILED AREAS	10.06	51
	EXTERNAL CORNER – NON-TILED AREAS	10.07	52
	FINISHING EXTERNAL CORNER – TILED AREAS	10.08	52



CONSTRUCTION DETAILS

General Non-Wet Areas

FIGURE 9.01 Friction Fit Head

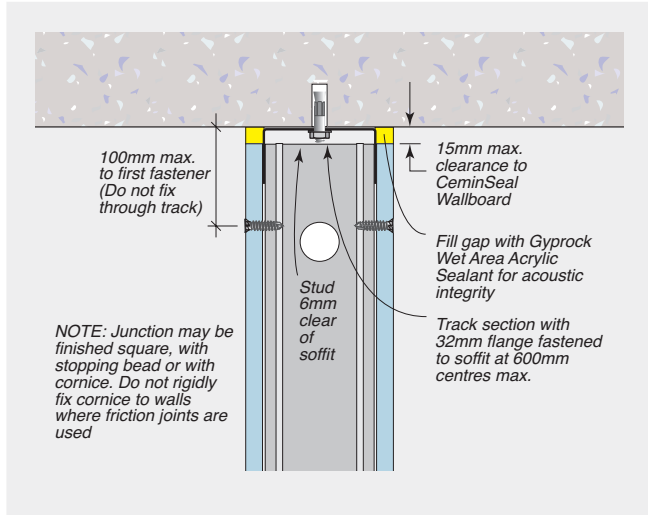

FIGURE 9.02 Wall Base Detail

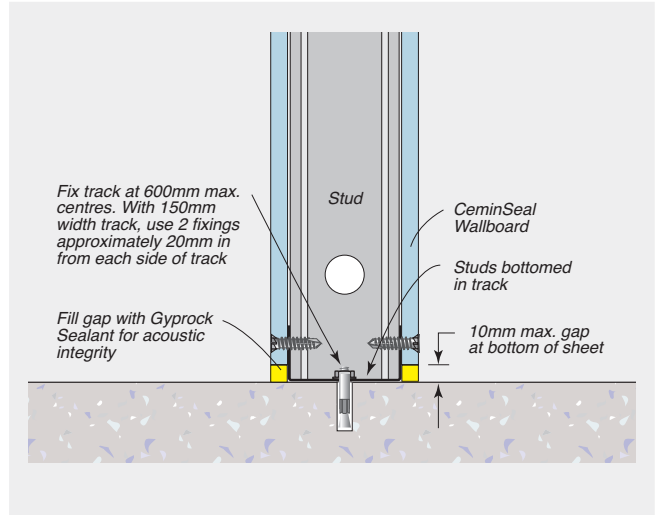

FIGURE 9.03 Tee Junction – Non-Tiled Walls

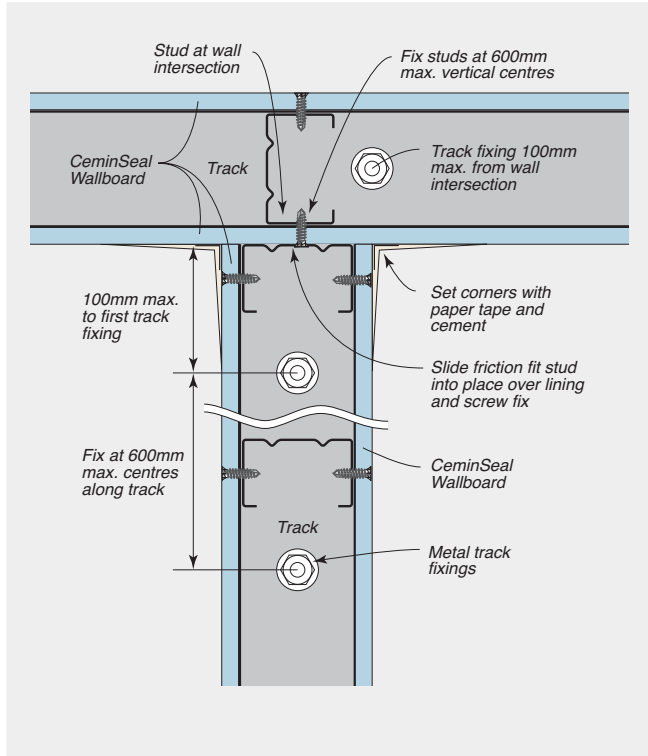
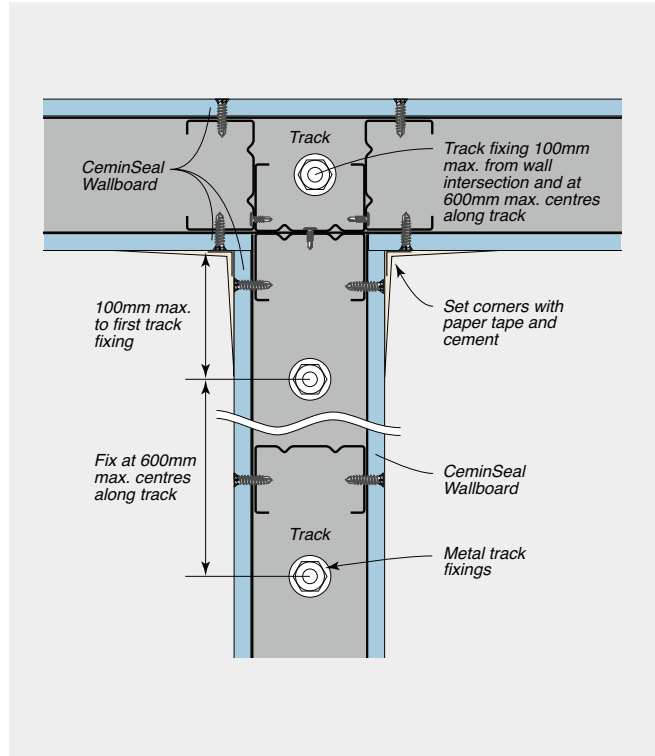

FIGURE 9.04 Tee Junction – Non-Tiled Walls – Alternative



CONSTRUCTION DETAILS



General Non-Wet Areas

**FIGURE 9.05** Stud Wall Junction with Masonry Wall

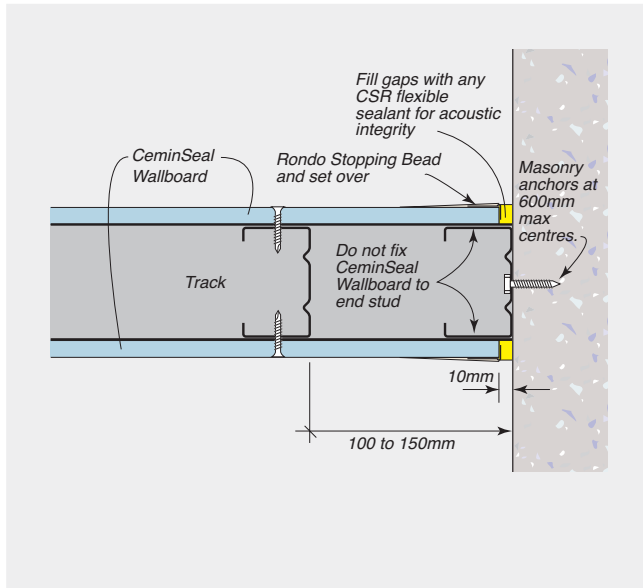

**FIGURE 9.06** Vertical Control Joint – Non-Tiled Wall  
(Only suitable for walls with no acoustic performance requirements).

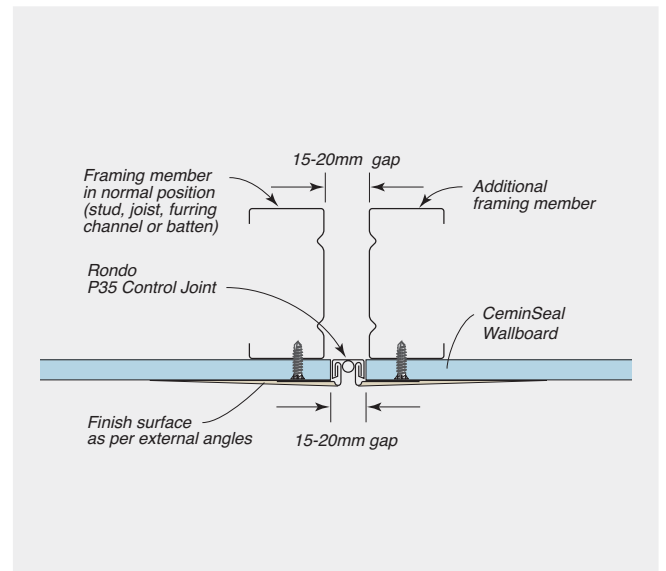

**FIGURE 9.07** Vertical Control Joint – Steel Stud Wall System  
(Maintains acoustic integrity of the wall system in which it is installed).  
For Rw up to 40, use backing rod only detail. For Rw greater than 40, use backing rod and sealant detail

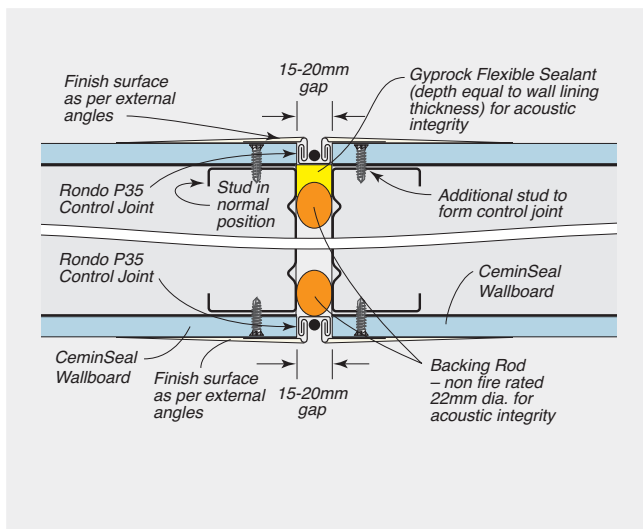

**FIGURE 9.08** Vertical Control Joint – Tiled Wall

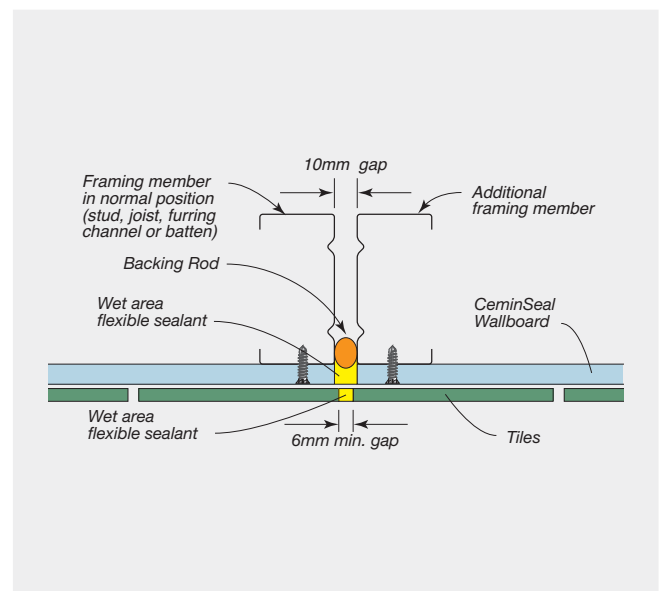



## CONSTRUCTION DETAILS

### Shower/Bath Wet Areas

#### Waterproofing in Wet Areas

The wet area details provided are based on an interpretation of those provided in National Construction Code (NCC) and Australian Standard AS 3740:2021 'Waterproofing of domestic wet areas'. These drawings should be considered as conceptual and are not intended to replace the NCC and Australian Standards, nor to overrule the expertise of builders and waterproofing contractors.

- An appropriate waterproof membrane is applied to the face of the Wallboard before tiling at the specified locations, and in accordance with the respective manufacturer's instructions. The extent of waterproof coverage is project specific and specified by the designer. A 'best practice' solution is the application of the membrane to the entire shower area to a minimum height of 1800mm from the finished floor surface or 50mm above the shower rose, whichever is highest. The membrane should extend 50mm minimum outside the shower area. Refer to appropriate illustrations.

#### Wet area walls in showers

- In an enclosed shower, the walls up to 1800mm above finished floor level of the shower or base of bath or tray, or 50mm above the shower rose, whichever is higher shall be water resistant and the following locations shall be waterproof:
  - Internal and external corners, joins and penetrations (fixings) of the water resistant substrate; and
  - 150mm minimum above finished tile level at wall to floor junctions, or 25mm above the maximum retained water level, whichever is greater.
- In an unenclosed shower, as for an enclosed shower but extending to 1500mm (horizontal projection) from the shower rose.
- In a shower-over-bath situation, as for unenclosed shower except the wall requirement may terminate at a suitable fixed shower screen. Horizontal surfaces supporting baths to be waterproof a minimum 150mm above the bath edge.

#### Wet area walls outside showers

- Wall to floor junctions to be waterproof.
- The wall 150mm above a bath and any fixed vessel such as a basin, sink, or tub if it is within 75mm of the wall, to be water resistant. Refer to details in the following section.

#### Preformed Shower Base and Tray

A preformed shower base has the advantage of being easy to install over floors of timber, compressed fibre cement sheet and concrete slabs, as well as ensuring that the wall linings are kept clear of any free water likely to accumulate on the shower floor.

The designer/installer of the shower base should consider:

- A number of treatments for the shower wall junctions are available depending on the class of membrane.
- Cut and install flashing angle to the wall/floor junction, if required by building regulations. Fix to floor only.
- A preformed shower base must be installed before the wall linings. Install vertical flashing to internal corner, fixing to studs at 600mm centres where appropriate. Carry corner flashing down over the shower base lip, stopping 6mm above shower base or floor finish. Flashing is to extend a minimum height of 1800mm from the finished floor surface, or 50mm above the shower rose, whichever is higher.
- Cut and fix the Wallboard, leaving a 6mm gap between the bottom edge of the sheet and the shower base, and where detailed, between sheets forming an internal corner. Neatly cut holes for plumbing penetrations. Refer to wall system fixing details appropriate for the installation.
- Caulk around plumbing penetrations, and, where detailed, at sheet bases and internal corners with flexible wet area sealant that is compatible with the other materials, i.e., waterproof membrane, other sealants and tile adhesive.
- Joint with a wet area base coat and tape.
- An appropriate waterproof membrane is applied to the face of the Wallboard before tiling at the specified locations, and in accordance with the respective manufacturer's instructions. The extent of waterproof coverage is project specific and specified by the designer. A 'best practice' solution is the application of the membrane to the entire shower area to a minimum height of 1800mm from the finished floor surface or 50mm above the shower rose, whichever is highest. The membrane should extend 50mm minimum outside the shower area. Refer to appropriate illustrations.
- A compatible tile adhesive must be used to fix tiles to the membrane.
- Refer to appropriate junction details.

CONSTRUCTION DETAILS



Shower/Bath Wet Areas

FIGURE 9.09 Preformed Shower Base Installation

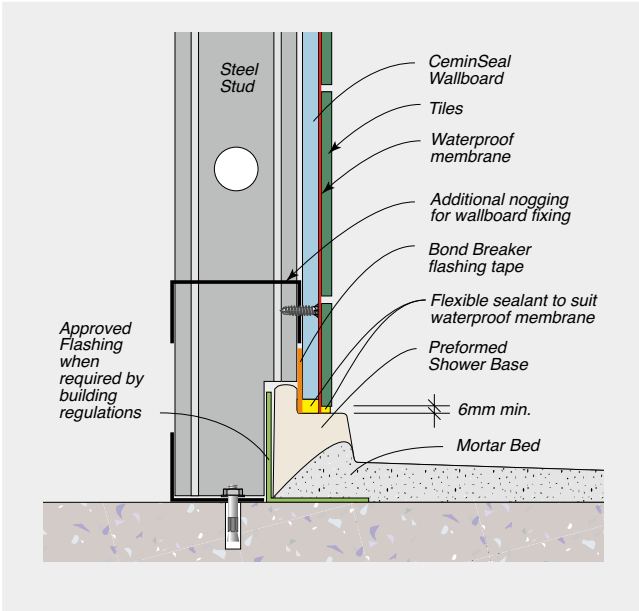

FIGURE 9.10 Preformed Shower Tray Installation

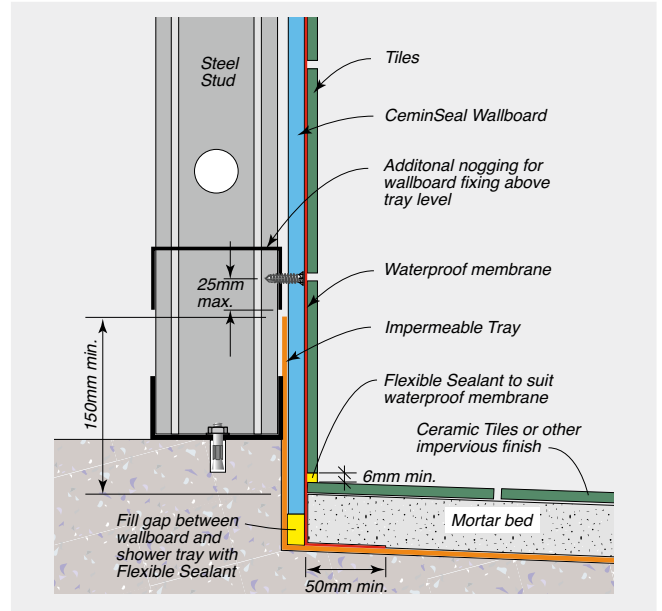

FIGURE 9.11 Typical Detail For Preformed Shower Base

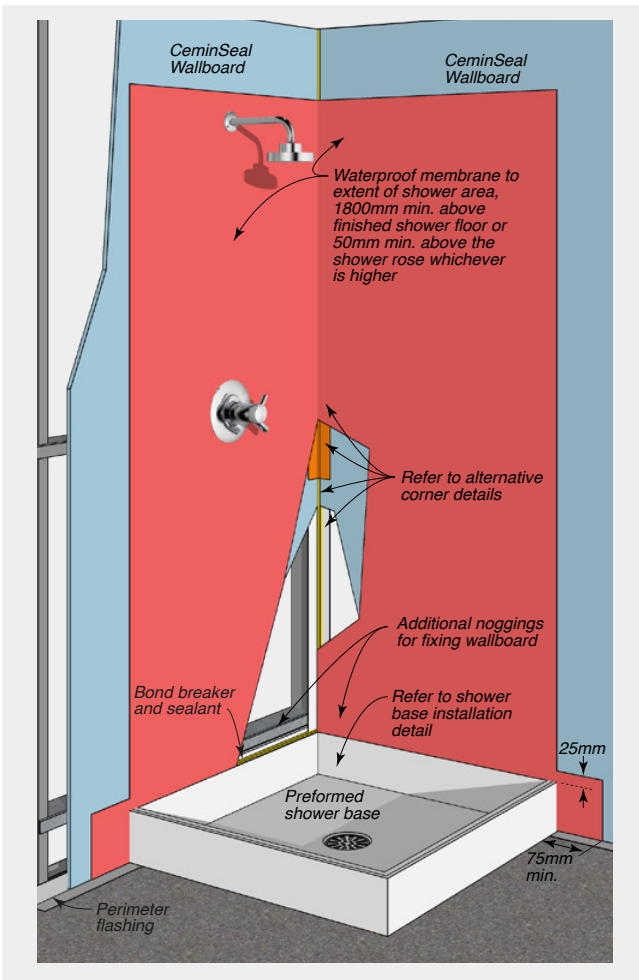
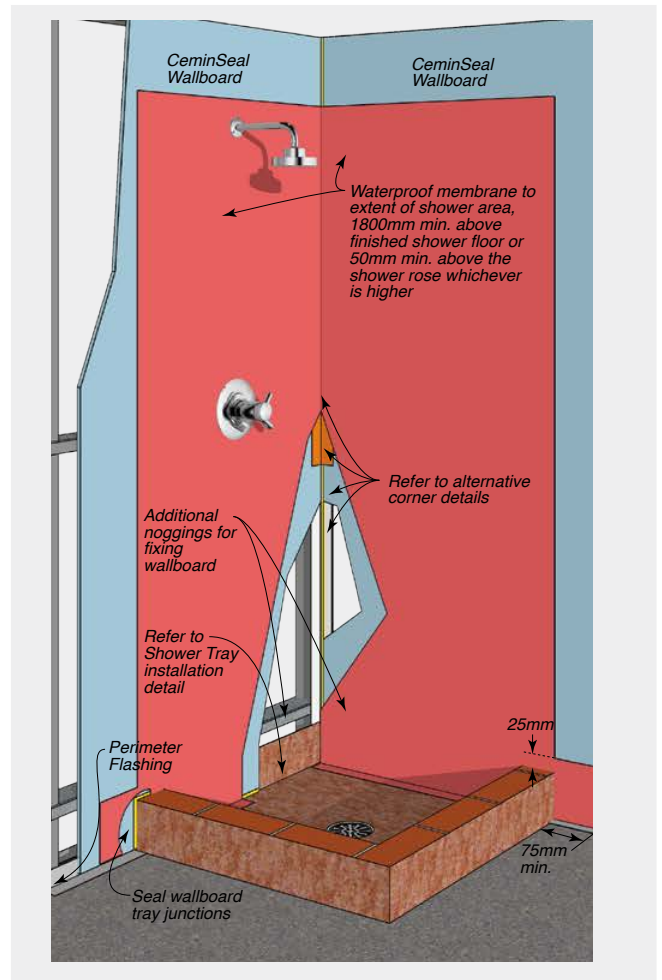

FIGURE 9.12 Typical Detail For Preformed Shower Tray





## CONSTRUCTION DETAILS

### Shower/Bath Wet Areas

#### Insitu-Formed Shower Membrane

Shower floors may be formed with a mortar bed and waterproof membrane. A number of treatments for the shower wall and floor junctions are available depending on the class of membrane. Membranes of Class II or Class III, are recommended at junctions.

- Cut and install flashing angle to the wall/floor junction if required by building regulations. Fix to floor only.
- Install flashing vertically to internal corners from 1800mm above finished floor surface or 50mm above the shower rose, whichever is higher, stopping 6mm above floor level. Fix to studs at 600mm vertical centres where appropriate.
- Cut and fix the Wallboard, leaving a 6mm gap between the bottom edge of the sheet and the shower floor, and where detailed, between sheets forming an internal corner. Neatly cut holes for plumbing penetrations. Refer to wall system fixing details appropriate for the installation.
- Caulk around plumbing penetrations and where detailed, at sheet bases and internal corners with an appropriate flexible wet area sealant that is compatible with the other materials, i.e., waterproof membrane, other sealants and tile adhesive.
- Joint sheets with a wet area base coat and tape.
- An appropriate waterproof membrane is applied to the face of the Wallboard and floor to form an in-situ tray before tiling at the specified locations, and in accordance with the respective manufacturer's instructions. The extent of waterproof coverage is project specific and specified by the designer. A 'best practice' solution is the application of the membrane to the entire shower area to a minimum height of 1800mm from the finished floor surface or 50mm above the shower rose, whichever is higher. The membrane should extend 50mm minimum outside the shower area. Refer to appropriate detail.
- A compatible tile adhesive must be used to fix tiles to the membrane.
- Refer to appropriate junction details.

**FIGURE 9.13** Insitu-Formed Shower Membrane – Class II Or III Membrane

(Provide a transition fillet of sealant at the edge of the flashing)

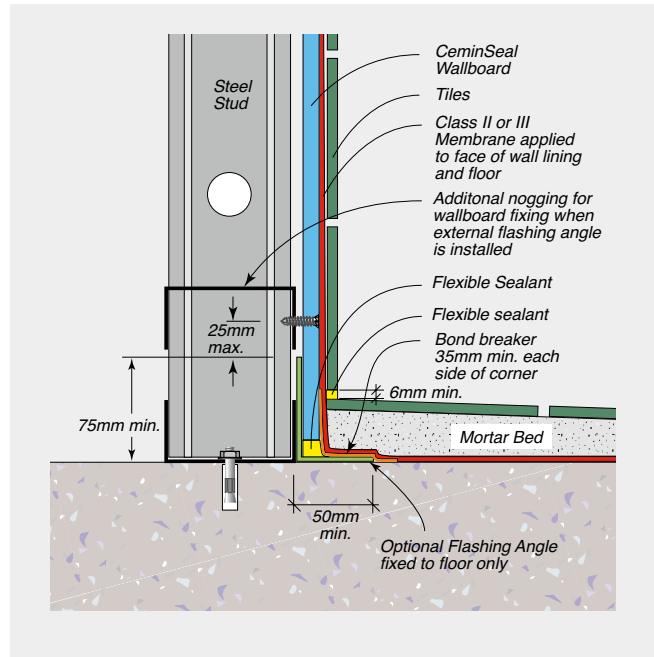

**FIGURE 9.14** Insitu-Formed Shower Membrane – Class III Membrane

(Provide a transition fillet of sealant at the edge of the flashing)

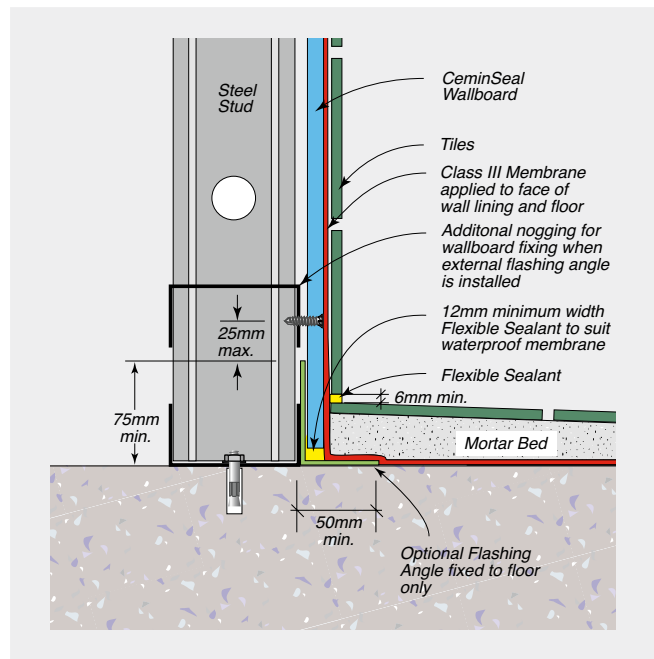



CONSTRUCTION DETAILS



Shower/Bath Wet Areas

FIGURE 9.15 Typical Detail for Insitu-Formed Shower Membrane

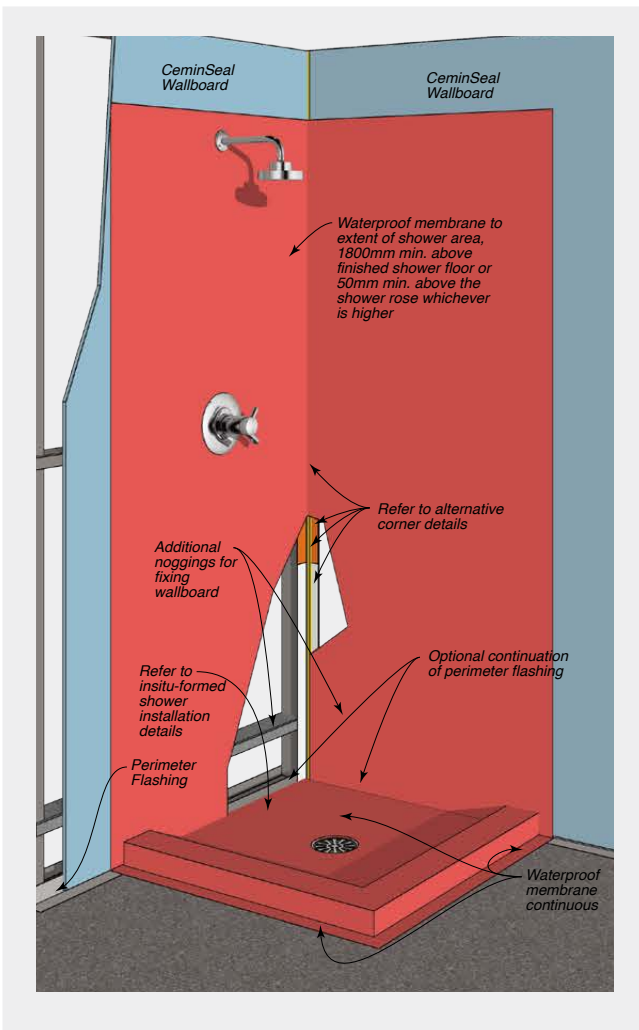
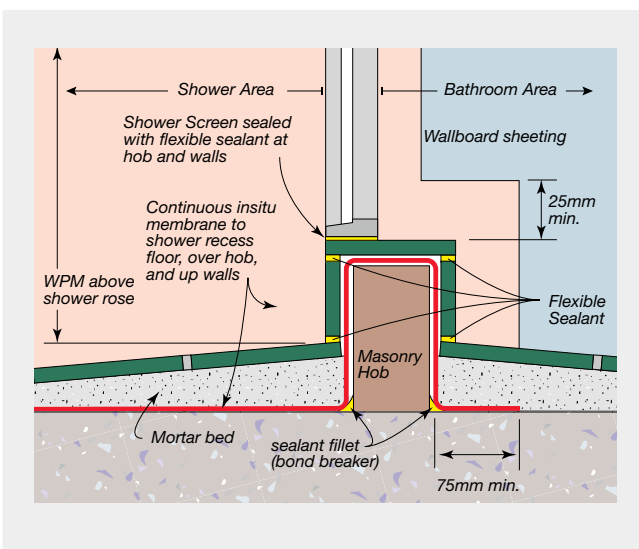

FIGURE 9.16 Insitu-Formed Shower Recess With Hob



Shower Area – Masonry Walls

Shower areas formed against masonry wall will require a steel furring channel system fixed to the masonry to support the Wallboard.

- Install vertical furring channels at maximum 600mm centres using clips and appropriate masonry fixings.
- Place J-Tracks as shown to support the edges of sheets.
- Provide suitable framing to support the bath and other fixtures such as soap holders and towel rails.
- Fix Wallboard to metal furring.
- Refer to appropriate junction details.

FIGURE 9.17 Preformed Shower Base

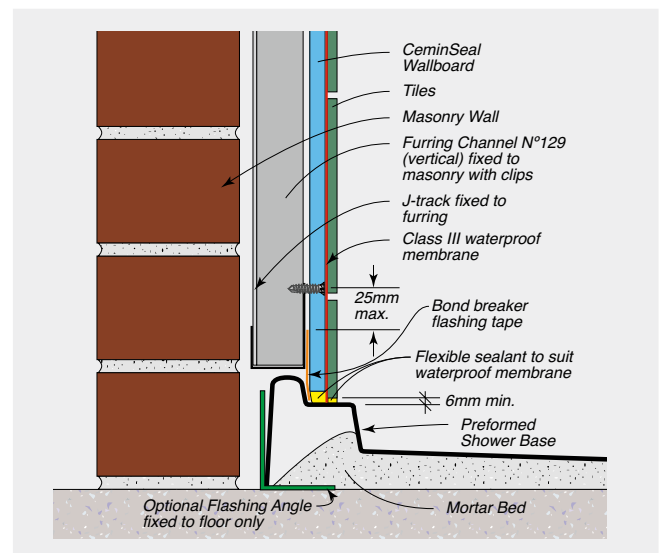
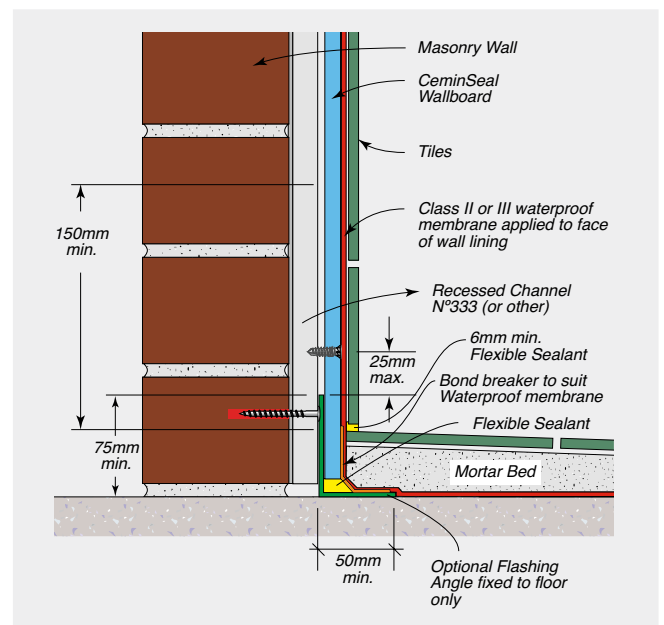

FIGURE 9.18 Insitu-Formed Shower Recess – Class II Or Class III Membrane





## CONSTRUCTION DETAILS

### Shower/Bath Wet Areas

#### Shower Over Bath – Unenclosed or Partially Enclosed

Cut and install flashing angle to the wall/floor junction if required by building regulations. Fix to floor only.

Install flashing vertically to internal corners from 1800mm above the finished floor surface or 50mm above the shower rose, whichever is higher stopping 6mm above floor level. Fix to studs at 600mm vertical centres where appropriate.

Cut and fix the Wallboard, leaving a 6mm gap between the sheet and the floor, between the sheet and the bath, and between sheets forming internal corner. Neatly cut holes for plumbing and bath penetrations. Refer to wall system fixing details appropriate for the installation

- Caulk around plumbing penetrations, and, where detailed, at sheet bases and internal corners with an appropriate flexible sealant.
- Joint with a wet area base coat and tape.
- Proprietary liquid membrane materials are applied to the face of the Wallboard and the floor. Always follow respective manufacturers' instructions.
- A compatible tile adhesive must be used to fix tiles to the membrane.
- Extent of floor treatment is shown for compressed fibre cement or concrete flooring only. For timber flooring, waterproof entire floor.

**FIGURE 9.19** Membrane Detail For A Semi-Enclosed Shower Over Bath Or Shower Area

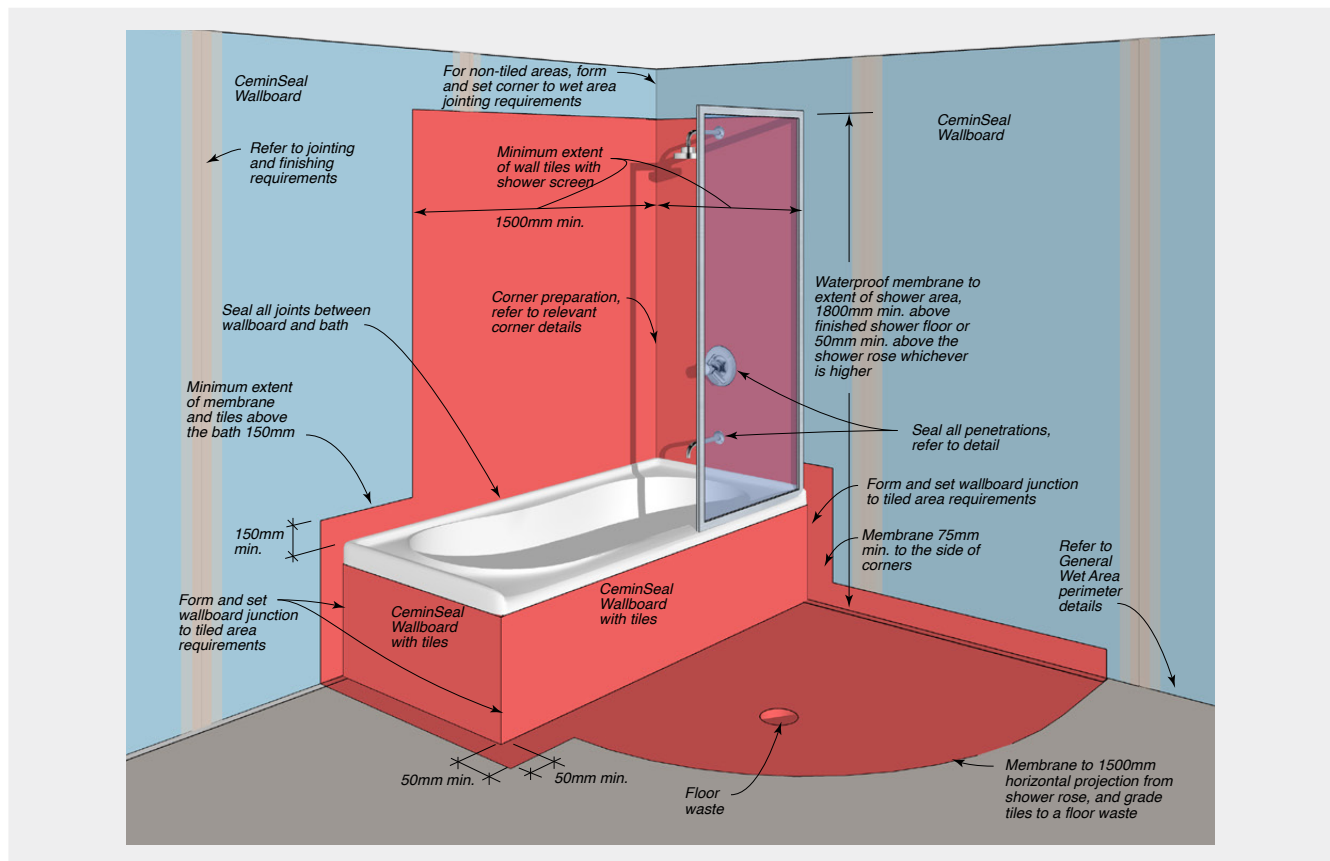

CONSTRUCTION DETAILS



Shower/Bath Wet Areas

FIGURE 9.20 Membrane And Tile Detail For An Unenclosed Shower Over Bath Or Shower Area

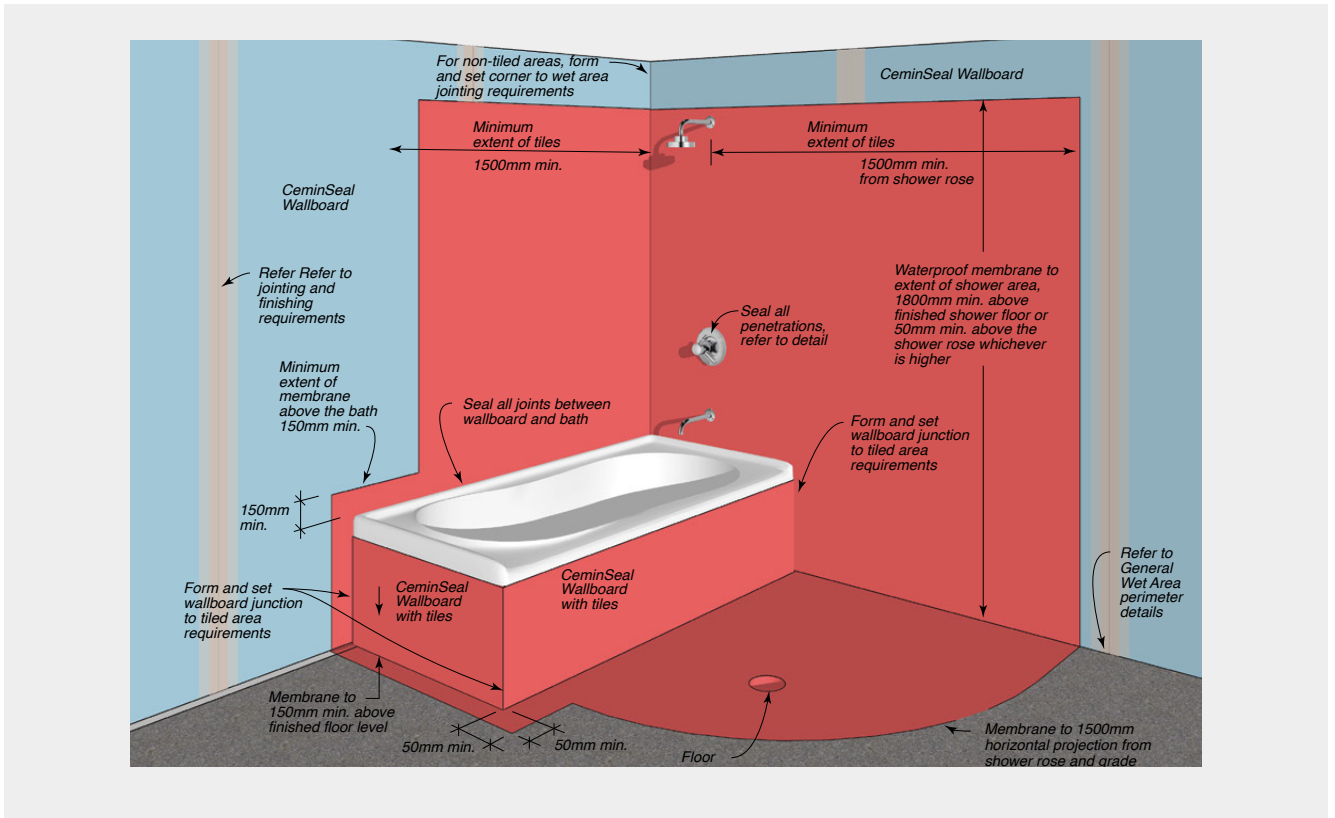

FIGURE 9.21 Internal Corner Detail – Class II Membrane (Provide back blocking or non-ferrous angle to studs to prevent differential movement.)

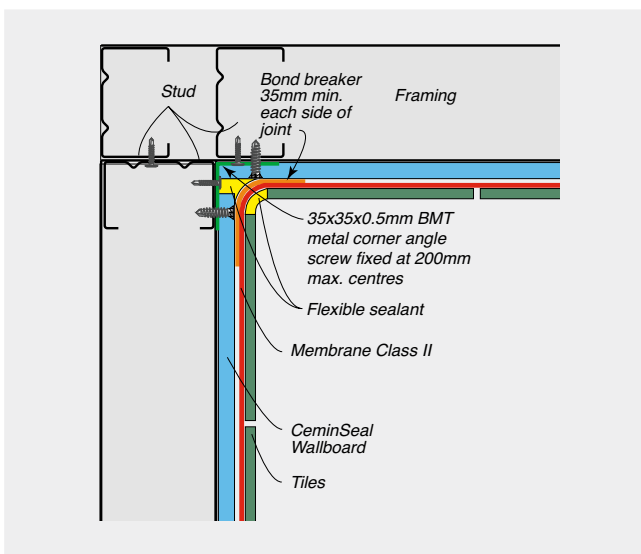
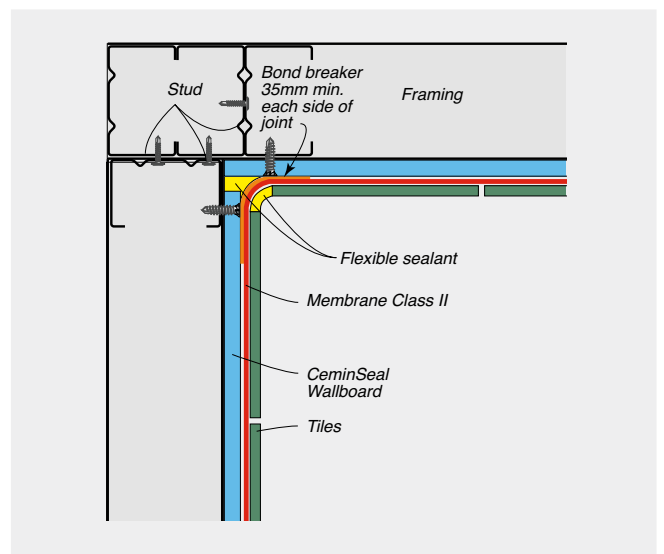

FIGURE 9.22 Internal Corner Detail – Class II Membrane (Provide back blocking or non-ferrous angle to studs to prevent differential movement.)





CONSTRUCTION DETAILS

Shower/Bath Wet Areas

**FIGURE 9.23** Internal Corner Detail – Class III Membrane  
(Provide back blocking or non-ferrous angle to studs to prevent differential movement.)

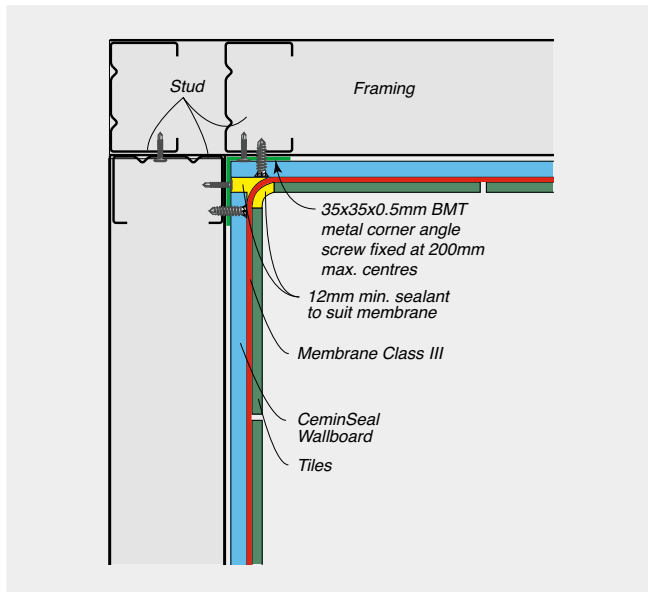

**FIGURE 9.24** Internal Corner Detail – Class III Membrane  
(Provide back blocking or non-ferrous angle to studs to prevent differential movement.)

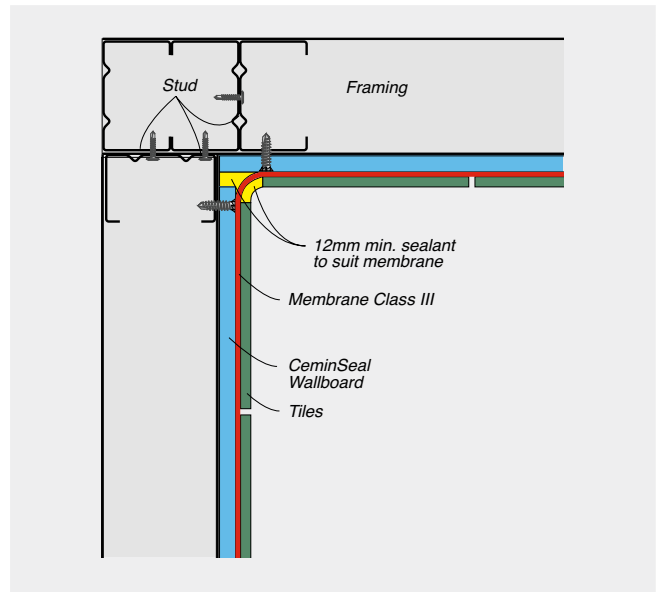

**FIGURE 9.25** Installation Layout For A Bath Without Shower

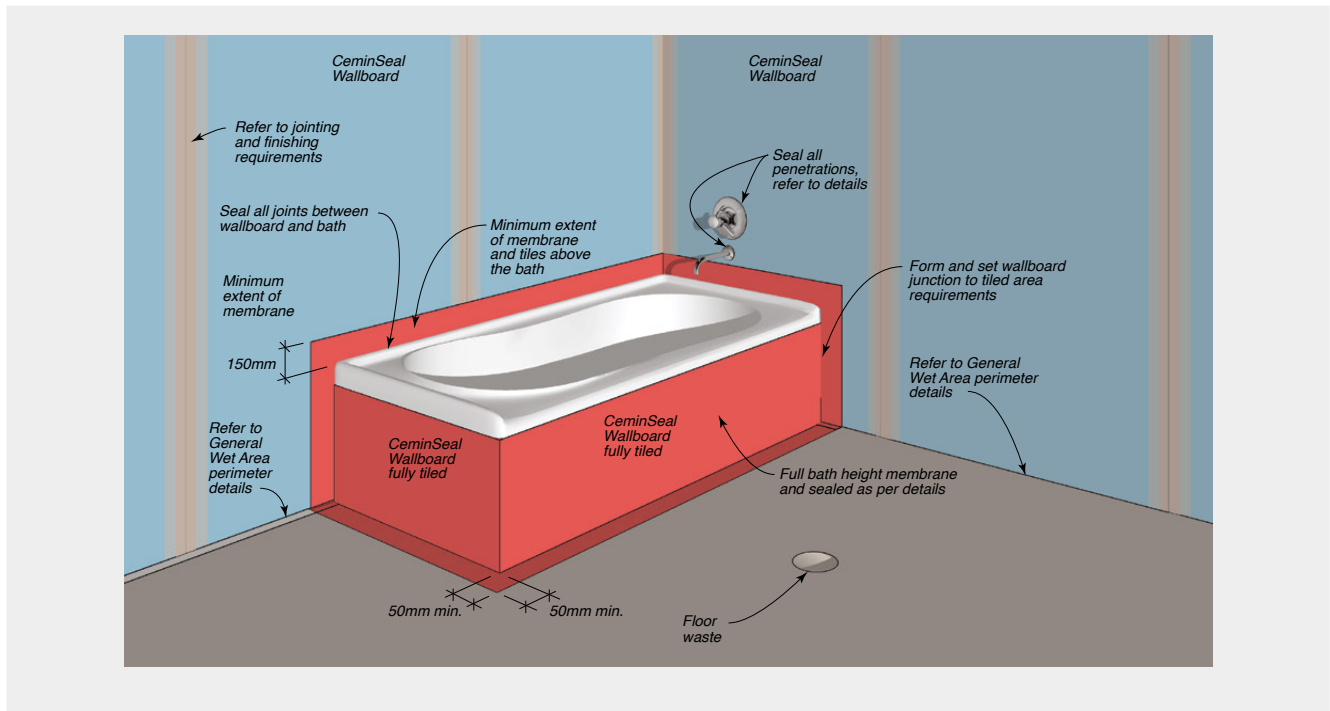

CONSTRUCTION DETAILS



Shower/Bath Wet Areas

FIGURE 9.26 Bath Installation To Stud Wall

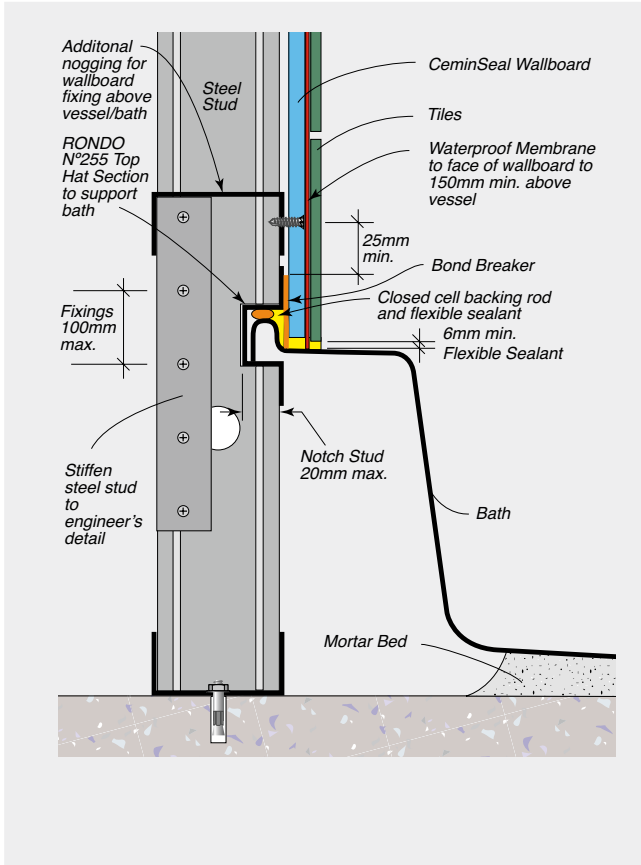
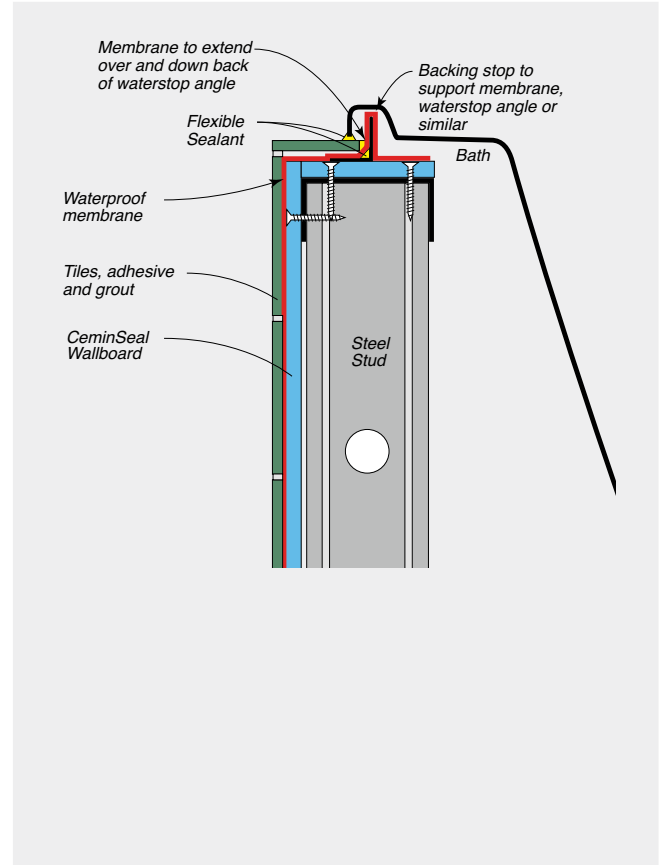

FIGURE 9.27 Bath Hob





CONSTRUCTION DETAILS

General Wet Areas

FIGURE 9.28 Typical Hand Basin – Membrane/Tiling Detail

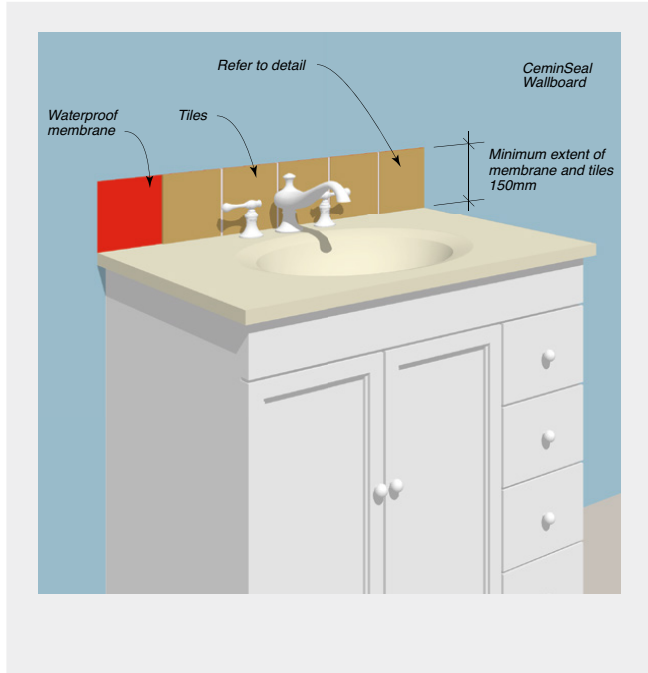

FIGURE 9.29 Laundry Tub/Sink Installation

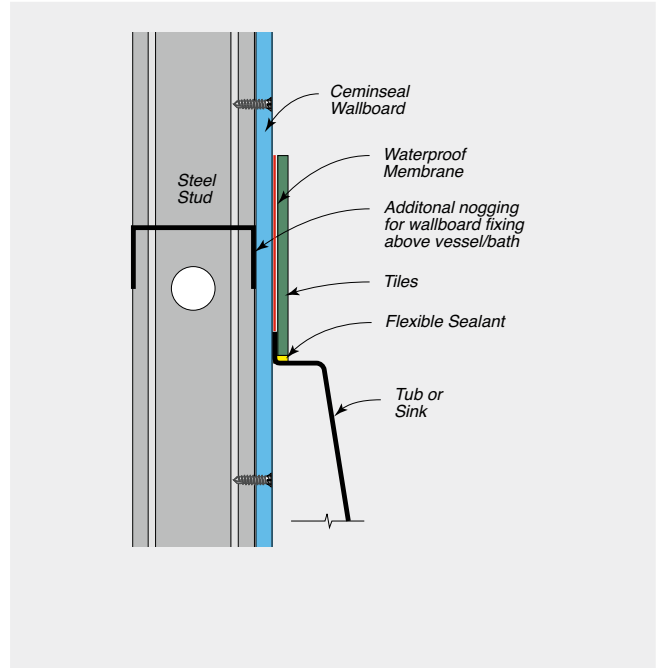

FIGURE 9.30 Plumbing Penetrations

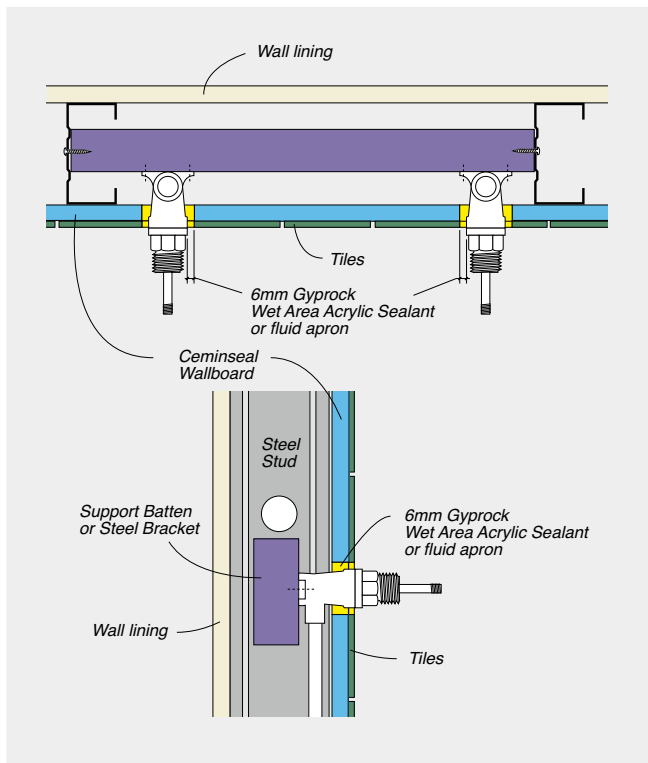
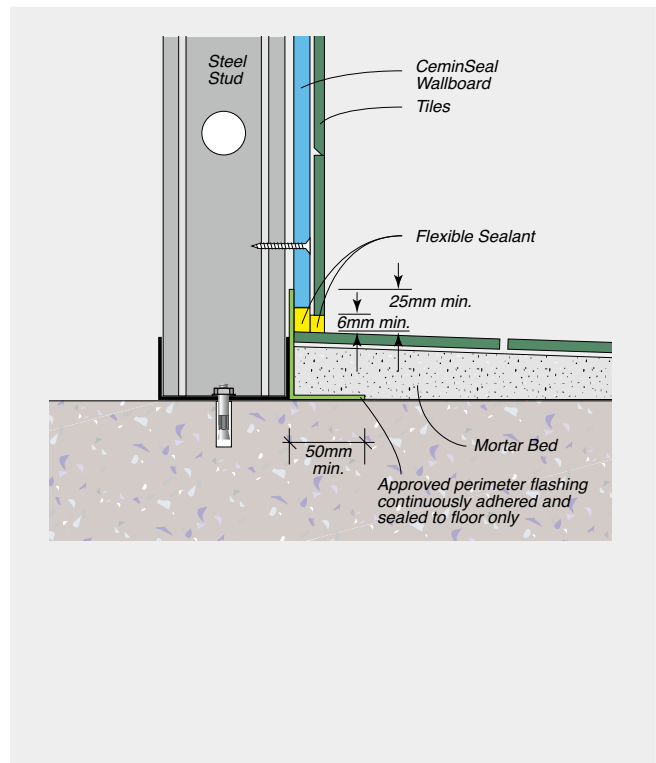

FIGURE 9.31 Perimeter Angle Flashing



# 10

JOINTING AND FINISHING

## 10

## JOINTING AND FINISHING

## Jointing and Finishing

Jointing and finishing of Cemintel Wallboard is to be carried out in accordance with the requirements of Table 10.01 and 10.02 (Jointing) and the following details, to reinforce joints, to protect corners, and to provide a smooth surface for decorating where required.

An acceptable level of finish in non-tiled areas requires a three-coat system, consisting of tape and tape coat, a second coat, and a finish (or topping) coat. In tiled areas, a two-coat system may be used.



### Jointing Compounds

Jointing compounds are classified as either setting type or drying type. Setting type compounds are fast drying for early application of subsequent coats and have a defined setting time e.g., 20, 45, 60 or 90 minutes.

Setting type compounds are: Base Coat 20; Base Coat 45; Base Coat 60; Base Coat 90; and Ultra-Base MR 60.

Additional coats may be applied over setting type compounds once they have gone hard (set), usually 40 minutes to two hours. A drying type compound must be used as a finish coat and must be completely dry before sanding. This usually takes about 24 hours.

Drying type compounds are: Wet Area Base Coat; Jointmaster and Ultra-Top; and are supplied as premixed product.

Drying type compounds will shrink and harden with evaporation of water. The joints must be allowed to set and appear completely dry before re-coating or sanding. Actual drying times will be extended in low temperature and high humidity conditions. Do not use a setting type compound over a drying type compound. Note that Gyprock Wet Area Base Coat sets very hard; apply accurately to avoid the requirement to sand.

It is recommended that a water-resistant compound be used at sheet joints in areas that are required to be waterproof or water resistant. Set all joints with Gyprock Wet Area Base Coat or Ultra-Base MR 60 and Gyprock Paper Tape. When the tape coat has dried, apply a second coat of the same compound, and cover all fastener heads. Joints in wet areas that are not tiled and not required to be waterproof or water-resistant should be set with compound and tape as detailed.

### Jointing Tape

Jointing tapes are used to provide strength and rigidity in the first coat of the jointing process. The tape is bedded in a base coat or all-purpose compound before the second coat and topping coat are applied. Tapes are also used in conjunction with a patching compound to repair dents, cracks and holes.

Gyprock Paper Tape and Fiba-Fuse tape have been developed to enable the preparation of strong joints and should be used on all butt and recess joints, and at internal corners. Paper Tape is creased along the centre line for better corners and performance in automatic taping tools.



## JOINTING AND FINISHING

10

**Site Mixing of Compounds**

For best results:

- Always use clean containers and mixing equipment as contamination by previously set compound will accelerate setting time.
- Always use clean water of drinking quality.
- Never mix different compounds together or mix old batches with new ones.
- Follow mixing instructions printed on each bag.
- Use compounds before the 'Best Before' date printed on the packaging.

When setting type compounds are used during hot, dry conditions, rapid evaporation of water and increased absorption by the lining surface can prevent the compound from setting correctly. This will result in the compound being soft and weak.

If jointing must be carried out under severe drying conditions, use fast setting products such as Base Coat 45 and mix only small quantities of compound. The compound should then be left standing for approximately 15 minutes to ensure that it sets soon after application to the joints. Additionally, depending on the severity of the drying conditions, the surface of the area to be jointed may require wetting with a brush before applying the compound. Drying-type compounds should not be used when the interior temperature is less than 10°C or could fall below 10°C before it has set.

**Preparation**

Fill any voids deeper than 4mm and gaps greater than 3mm wide with base coat and allow to dry before jointing. All surfaces must be free of dirt, oil or foreign matter that could reduce bond.

**TABLE 10.01** Jointing Compound Selection – Hand or Mechanical Application

Application	Base coat	Tape	Second coat	Finish coat
Wet areas - tile finish	Wet Area Base Coat Ultra-Base MR 60	Paper Tape	Wet Area Base Coat Ultra-Base MR 60	Nil

Note: Refer to figure 7.01 to 7.06 for Cemintel wallboard installation method

**TABLE 10.02** Jointing Compound Selection – Hand or Mechanical Application (for Alternative Installation Method)

Application	Base coat	Tape	Second coat	Finish coat
General areas - paint finish	Base Coat 20	Paper Tape Fiba-Fuse	Base Coat 20*	Jointmaster
	Base Coat 45		Base Coat 45*	Ultra-Top
	Base Coat 60		Base Coat 60*	Pre-Mixed Total Joint Cement
	Base Coat 90		Base Coat 90*	Easy-Finish
General areas - tile finish	Ultra-Base MR 60		Ultra-Base MR 60*	Nil
	Pre-Mixed Total Joint Cement		Pre-Mixed Total Joint Cement	
Wet areas - tile finish	Wet Area Base Coat Ultra-Base MR 60	Paper Tape	Wet Area Base Coat Ultra-Base MR 60	Nil

Note: Refer to figure 8.05 to 8.08 for Cemintel wallboard installation method.

\*Setting type compound. Do not use a setting compound over a drying type compound.

**TABLE 10.03** APPROXIMATE QUANTITIES PER 100m<sup>2</sup> WALLBOARD (HORIZONTAL SHEETING)^

Tape + Second Coats	Approx Qty	Finish Coat	Approx Qty
Base Coat 20/45/60/90	16kg	Jointmaster	10kg
Ultra-Base/MR60	13kg	Ultra-Top	6kg
Pre-mixed Total Joint Cement	31kg	Easy-Finish	8kg
Wet Area Base Coat	15kg		

^ Allow 20% more jointing material for vertical sheeting.

## Jointing Procedure

Jointing with mechanical tools is the most common method in use, and the method is detailed here. Jointing by traditional hand methods may also be used. For tiled areas, only the tape and second coats are required. As butt joints and cut edges are to be recessed on site, the same method is used for all sheet joints.

Premixed compounds for taping and jointing boxes should be used directly from the bucket, but can, if necessary, be thinned down with water, used sparingly. Follow the instructions provided on the product packaging.

### Tape Coat

- Using a taping machine, apply tape and compound centrally to the recessed joint.
- Using a joint knife, immediately press tape into the joint and cover the tape with a thin coat of compound. Feather the edges and clean off excess compound.

**NOTE:** A minimum 1mm compound is to be left under the tape.

- Cover all fastener heads and fill any surface damage with compound.
- Allow setting-type compounds or Wet Area Base Coat to set completely. Allow other drying type compounds to harden for 24 hours before proceeding.

### Second Coat

- Using a 200mm plaster box, apply a second coat to the recessed joint.
- Cover fastener heads with a second coat of compound, laid in a different direction, and extending beyond the first coat by about 25mm.
- Allow compound to set/harden before proceeding.

### Finish Coat

- Using a 250mm plaster box, apply a third coat to the recessed joint.
- Cover fastener heads with a third coat of compound, laid in a different direction, extending beyond the previous coat by about 25mm. Ensure that the edges of the compound are neatly feathered and that there are no trowel edge marks left in the final stopping.
- Allow compound to harden before proceeding.

### Sanding

- Use a power sander to smooth the compound.

**Caution:** If previous coats of drying type compounds are not thoroughly dry before application of subsequent coats, imperfections can result from delayed shrinkage of the compound.

**FIGURE 10.01** Recessed Edge – Non-Tiled Areas

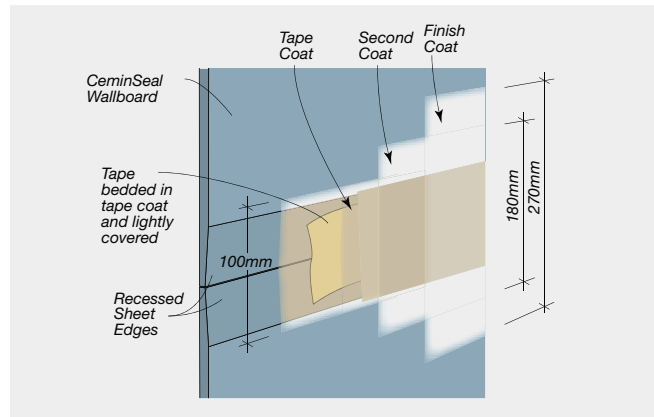

**FIGURE 10.02** Butt Joint – Non-Tiled Areas

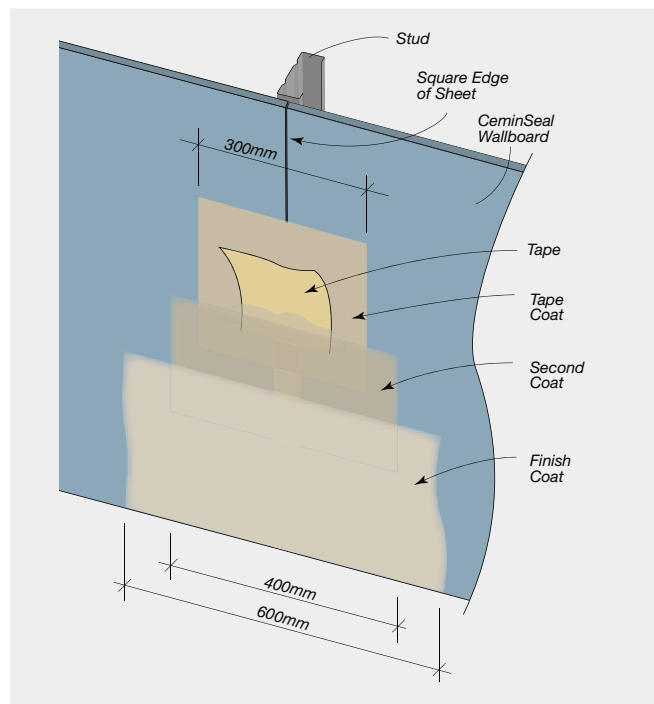

**FIGURE 10.03** Jointing Butt Or Recessed Edge – Tiled Areas

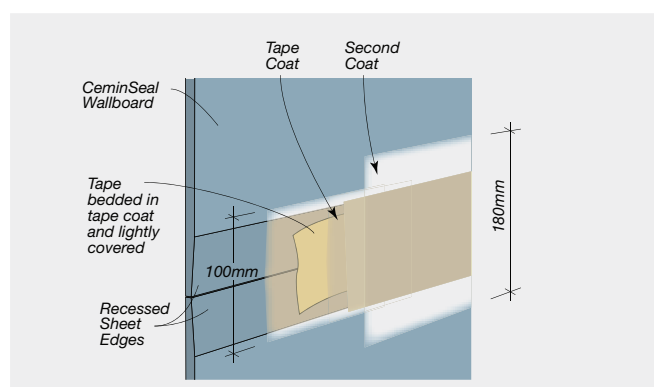

## JOINTING AND FINISHING

10

**Jointing of Internal Corners**

Method for non-tiled areas. For tiled areas, no setting is required.

**Tape Coat**

- Remove debris from corner and floor.
- Using a taping machine with tape creaser in place, apply tape and compound centrally to the joint.
- Follow immediately with a corner roller, pressing tape into the joint.
- Using a corner setting tool, cover the tape with a thin coat, feather the edges and clean off excess compound.

**NOTE:** A minimum 1mm compound is to be left under the tape.

- Allow setting-type compounds to set completely, and drying type compounds to harden for 24 hours before proceeding.

**Finish Coat**

- Using a corner box with finisher attachment or corner setting tool, apply a thin coat of finishing compound over the tape coat, ensuring that the edges are well feathered.
- Smooth joint with corner setting tool.
- Allow compound to harden before proceeding.

**Sanding**

- Hand sand smooth with 150/180 grit paper or cloth, or with 220 grit sanding mesh and a sanding block.

**Caution:** If previous coats of drying type compounds are not thoroughly dry before application of subsequent coats, imperfections can result from delayed shrinkage of the compound.

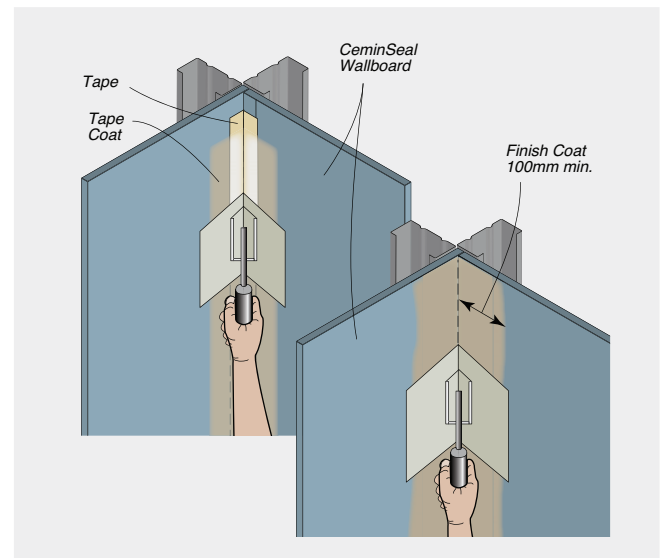
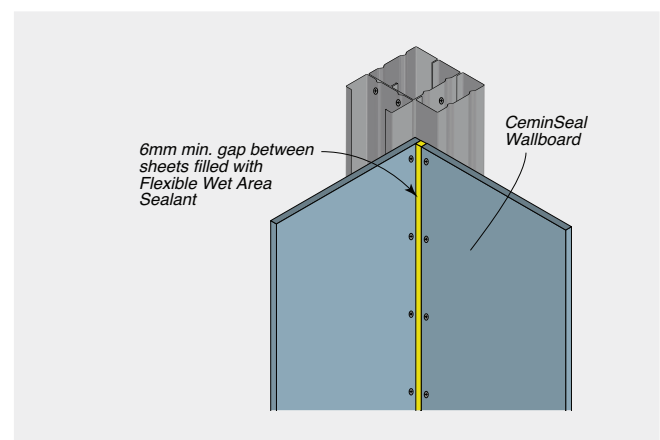
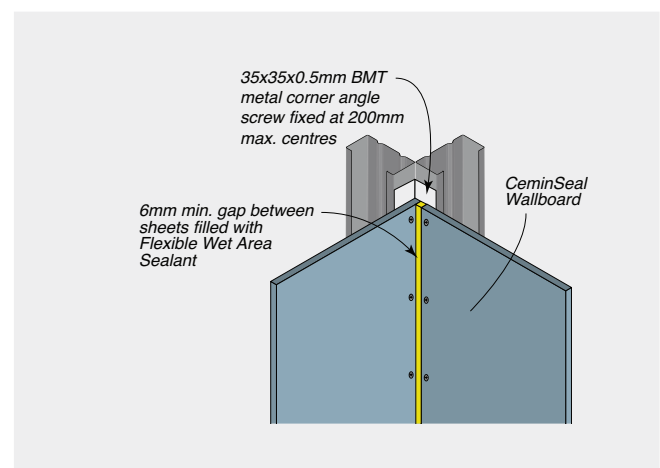
**FIGURE 10.04** Internal Corners – Non-Tiled Areas**FIGURE 10.05** Finishing Internal Blocked Corner – Tiled Area**FIGURE 10.06** Finishing Internal Corner – Tiled Area

## Jointing of External Corners

### Tape Coat

- Remove debris from corner and floor.
- Using tape machine, apply tape and compound centrally to the joint.
- Follow immediately with a tool, pressing tape into the joint.
- Using a corner setting tool, cover the tape with a thin coat, feather the edges and clean off excess compound.

**NOTE:** A minimum 1mm compound is to be left under the tape.

- Allow setting-type compounds to set completely, drying type compounds to harden for 24 hours before proceeding.

### Apply Corner Bead

- Position external angle bead over the corner and sight it to ensure straightness before fastening both flanges at 300mm centres.
- Using a joint knife, cover the bead with a thin coat. Feather the edges and clean off excess compound.
- Allow setting-type compounds to set completely, and drying type compounds to harden for 24 hours before proceeding.

### Second Coat

- Using a plaster box, with bead guide attached, apply a minimum 140mm width compound coat to each side of the corner. This will also feather the edges.
- Allow compound to set/harden and trim excess material.

### Finish Coat

- Using a 250mm plaster box, with bead guide attached, apply a finish coat each side of the corner.

### Sanding

- Hand sand smooth with 150/180 grit paper or cloth, or with 220 grit sanding mesh.

**Caution:** If previous coats of drying type compounds are not thoroughly dry before application of subsequent coats, imperfections can result from delayed shrinkage of the compound.

**FIGURE 10.07** External Corner – Non-Tiled Areas

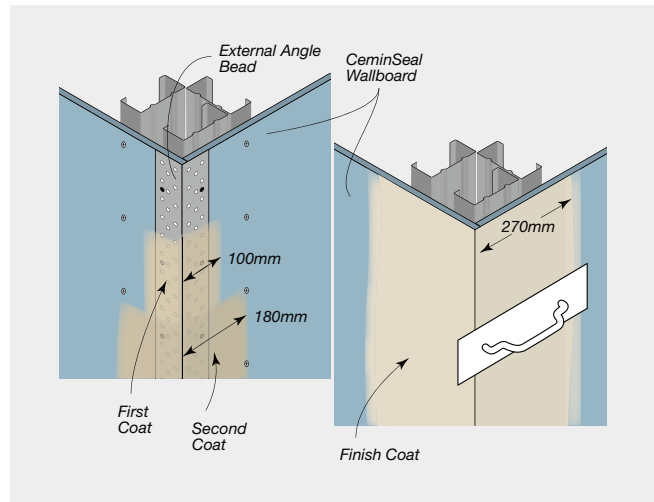

**FIGURE 10.08** Finishing External Corner – Tiled Area

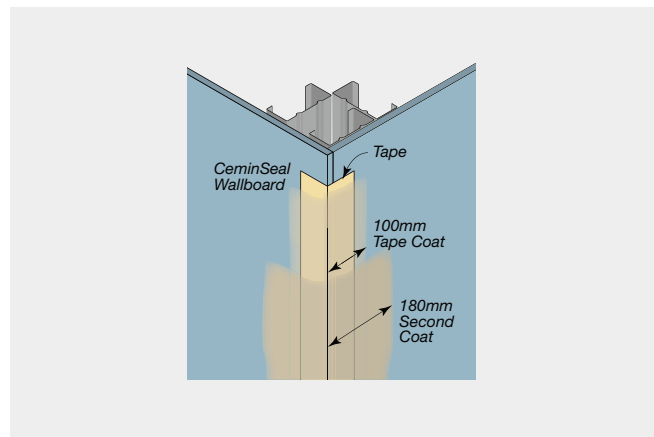

## JOINTING AND FINISHING

10

## Decoration

Interior Wallboard surfaces may be decorated in any of a variety of finishes including flat, semi-gloss or gloss paint, wallpaper or vinyl, texture or stipple, or tiles.

Guidance towards a finished surface with an even texture and appearance of flatness in preparation for brush, spray or roll painting is provided in AS/NZS 2311:2017 'Guide to the painting of buildings'.

### Surface Preparation

All joint stopping must be sanded smooth. Remove all loose dirt and dust with a soft brush or dry cloth. Ensure that the joint treatment is thoroughly dry before applying sealer or paint. Gyprock One Finish is suitable for application to the entire wall surface to assist in concealing surface imperfections and texture variations.

### Wallpaper & Vinyl

To enable removal of wallpaper and vinyl without damaging the Wallboard, seal the surface with a pigmented solvent-based sealer.

### Paint Finishes

Select a proprietary paint system and apply all paints strictly in accordance with the respective manufacturer's instructions. Roll coated paints generally have a greater coating thickness and create a similar texture on both the Wallboard and the jointing compounds.

The use of a preparatory coat over the entire surface is recommended prior to application of the finish coats due to the differing texture and porosity of uncoated Wallboard and areas which have received joint treatment. Recommended paint systems typically consist of one coat of sealer followed by two coats of finishing paint.

### Preparatory Coat

The chosen proprietary brand sealer should be formulated to fulfil the following functions:

- Equalise variations in porosity over the entire surface.
- Provide a bonding surface or key for the finishing coats.
- Stop the migration or bleeding of chemicals from the substrate which could affect the performance of the finishing coat.
- Conceal the difference in texture between the fibre cement surface and the joints.

### Important:

- In areas of high humidity such as bathrooms, kitchens, laundries and toilets, a paint system that protects the Wallboard and joints from moisture must be used. Refer to paint manufacturer's recommendations.
- When applying the preparatory coat, apply a sufficient thickness to ensure that the surface is completely covered. Do not over-spread the paint.
- To avoid paint lifting over jointed areas, do not overwork or over-roll the paint when applying the preparatory coat.
- Allow the preparatory coat to dry thoroughly. If necessary, lightly sand between coats of paint to remove any nap lift or other surface blemishes.
- In accordance with normal building practice, application of a finish is deemed to be acceptance of the substrate.

### Finishing Coats

Always follow the manufacturer's instructions for application and recoating. For best results, apply the coatings with a roller. This helps to achieve a full even coat and a light, uniform texture over the entire surface. Refer to AS/NZS 2311:2017 and/or paint manufacturer's recommendations for specific roller nap length for the desired finish.

### Tiling

Tiles are typically required in waterproof and water-resistant areas. The tile adhesive must be compatible with the any waterproofing membrane used. Proprietary tile adhesives that meet the requirements of AS ISO 13007.1:2020 'Ceramic tiles - Grouts and adhesives'. are recommended. For best results, spread tile adhesive directly onto the surface to a depth of about 3mm, then 'rib' in a horizontal direction with a notched trowel having approximately 6mm x 6mm notches.

It is important to strictly follow the membrane/sealer and tile adhesive manufacturer's instructions to ensure that the system will perform satisfactorily and will provide suitable long-term performance. Some products require primers before application. Allowance must be made for movement by leaving a gap of 3mm between tiles in each vertical corner, as shown.



**SAFETY, HANDLING, GENERAL CARE  
+ WARRANTY**

## SAFETY, HANDLING, GENERAL CARE + WARRANTY



### Health, Safety and Personal Protection Equipment (PPE)

**Fibre Cement contain silicas that are harmful if inhaled. Protective clothing and breathing equipment should be worn when cutting products.**

When cutting, drilling or grinding fibre cement panels using power tools, always ensure the work area is properly ventilated.

#### Managing Respirable Crystalline Silica Dust

Crystalline Silica is everywhere. It is found naturally in stone, rocks, sand, gravel and clay. Sand is one of the raw materials in Fibre Cement. Respirable Crystalline Silica dust is the fine dust that's created when you use power tools to cut, drill, grind, chip or sand materials and products that contain crystalline

An approved dust mask (AS/NZS 1715 and AS/NZS 1716) and safety glasses (AS/NZS 1337) must be worn. Cemintel recommends that hearing protection also be worn.

Safety Data Sheet information is available at [www.cemintel.com.au](http://www.cemintel.com.au)

silica. This dust is of concern due to its size as it gets caught deep in your lungs and can cause long term damage.

IF YOU USE THE CORRECT SAFETY EQUIPMENT AND PPE, FIBRE CEMENT IS SAFE TO USE.



#### Cemintel Safety Requirements

1 - Cut Outdoors*	The ventilation outdoors is greater than that indoors, and therefore should reduce exposure.
2 - Use On-Tool Dust Extraction	Use on-tool dust extraction when using power tools to drill and cut Fibre Cement, with a vacuum that contains a HEPA M Class filter.
3 - Correct Saw and Blade	Use a plunge saw with a specifically designed Fibre Cement blade
4 - Don't Sweep, Vacuum instead	When completing your work vacuum with a HEPA M Class filter, rather than a broom as sweeping creates more dust.
5 - Use Correct Respirator	Use a half face P1 or P2 respirator. It is essential that the respirators are Fit Tested and workers are cleanly shaven to obtain a good seal

\* Even though not recommended, indoor cutting can be completed when using an onsite cutting room with exhaust ventilation and a M class filter at a minimum, on-tool dust extraction with a vacuum with a HEPA M Class filter, a Full Face P2 respirator and conducting local occupational and static air monitoring to validate effectiveness of control measures.

### Safety, Handling and Maintenance

#### Storage

All Cemintel panels must be stacked flat, clear of the ground and supported at 300mm maximum centres on a level platform. Panels must be kept dry, preferably stored inside the building. Panels must be dry prior to fixing, hence if it is necessary to store outside, the product must be protected from the weather.

#### Handling

Pre-finished products and must be treated with care during handling to avoid damage to edges, ends and prefinished surface. Panels should be carried horizontally on edge by at least two people.

Consideration should be given to planning the order of other trades that might stain or damage the panels.

Any splashings of mud, cement, mortar and the like should be removed immediately.

#### Cutting

Panels should be fully supported and cut from the back using a power saw. Cemintel recommends using the Makita Plunge Cut Saw with guide rail and appropriate blade, together with the appropriate dust extraction system. All exposed cut edges **MUST BE SEALED WITH CEMINTEL EDGE SEALER TO PREVENT MOISTURE ABSORPTION.**

#### Mitres

It is not recommended to mitre panel edges as this can cause delamination of the face.

#### Penetrations

Penetrations in panels may be cut or drilled prior to installation. Cut from the back or drill from the front. Mask, prime and fill gaps with sealant in accordance with recommended methods and products.

### Warranty

Cemintel CeminSeal® Wallboard sheets have a product warranty of 25 years. The full product warranty is available for download at [cemintel.com.au](http://cemintel.com.au)



---

## Our Offices

### **Sydney**

376 Victoria Street  
Wetherill Park NSW 2164

### **Adelaide**

Lot 100 Sharp Court  
Mawson Lakes SA 5095

### **Darwin**

Cnr Stuart Highway  
& Angliss Street  
Berrimah NT 0828

### **Melbourne**

277 Whitehall Street  
Yarraville VIC 3013

### **Perth**

19 Sheffield Road  
Welshpool WA 6106

### **Brisbane**

768 Boundary Road  
Coopers Plains QLD 4108

### **Hobart**

11 Farley Street  
Derwent Park TAS 7009

**cemintel.com.au**

1300 236 468

For Design and Technical Support:

**DesignLINK** – 1800 621 117

Cemintel is a trading entity of CSR Building Products Limited (ACN 008 631 356).

The products referred to in this document have been manufactured by or on behalf of CSR Building Products Limited ("CSR") to comply with the National Construction Code of Australia (NCC) and any relevant Australian Standards. While any design or usage guidelines set out in this document have been prepared in good faith by CSR, they are of a general nature only and are intended to be used in conjunction with project specific design and engineering advice.

It is the responsibility of the customer to ensure that CSR's products are suitable for their chosen application, including in respect of project-specific matters such as, but not limited to structural adequacy, acoustic, fire resistance/combustibility, thermal, and weatherproofing requirements. All information relating to design/installation/application of these products is offered without warranty and no responsibility can be accepted by CSR for errors and omissions, or for any use of the relevant products not in accordance with CSR's technical literature or any other relevant industry standards. For current technical and warranty documentation relating to Cemintel's products, visit Cemintel's website at [www.cemintel.com.au](http://www.cemintel.com.au).

05/2024