

CEMINTEL®



CEMINTEL RIGID AIR BARRIER
For pressure equalised facade systems

TABLE OF CONTENTS

01 INTRODUCTION	2	05 COMPONENTS + ACCESSORIES	11
Introduction	2	06 SYSTEM ENGINEERING	13
02 PRODUCT OVERVIEW	3	Design, Detailing and Performance	
Cemintel Rigid Air Barrier	4	Responsibilities	14
03 SYSTEM OVERVIEW	5	Span Tables /Wind Loads & Fastener	
Air Barrier	6	Spacings	15
Applications	7	07 INSTALLATION	20
04 DESIGN CONSIDERATIONS	8	Checklist – Prior to Installation	21
General	9	Installation of Cemintel Rigid Air Barrier™	22
Pressure Equalisation	9	08 CONSTRUCTION DRAWINGS	
Control Joints	9	+ DETAILS	24
Panel Layout	9	09 SAFETY, HANDLING, GENERAL CARE	
Structural	9	+ WARRANTY	31
Durability	10	Health, Safety and PPE	32
Moisture Management	10	Safety, Handling & Maintenance	32
Extreme Climate Conditions	10	Warranty	32
Other Design Considerations	10		

Introduction

Cemintel Rigid Air Barrier (RAB) is designed for use as part of a pressure equalised cladding system to produce effective weather-resistant facades.

Key components of pressure equalised systems are – a cladding or rain screen; a drained and ventilated cavity; and an air barrier.

Cemintel offers a number of external wall claddings that are suitable for use as part of a pressure equalised façade system.

The cavity allows pressure equalisation to occur, with ventilation provided through openings at the base and head of the wall. This also assists to prevent moisture build up and reduces the risk of moisture penetration, allowing the building shell to dry out, creating a healthier, more breathable building.

Cemintel Rigid Air Barrier™ (RAB) fibre cement panels are suitable for high wind pressures and for projects that are left unclad for extended periods which may require resistance to damage during construction.

This Design and Installation Guide has been prepared as a general guide and includes design considerations, system engineering and common applications. It assumes that the user has an intermediate knowledge level of building design and construction. In no way does it replace the services of the building professionals required to design projects, nor is it an exhaustive guide of all possible scenarios. It is the responsibility of the architect, designer and various engineering parties to ensure that the details in this Design and Installation Guide are appropriate for the intended application.



022

PRODUCT OVERVIEW

Cemintel Rigid Air Barrier

- Cemintel Rigid Air Barrier is a 6mm fibre cement panel consisting primarily of Portland Cement, cellulose fibres, sand and water. Cemintel Rigid Air Barrier sheeting conforms to the requirements of AS/NZS 2908.2 – Cellulose-cement products, Part: 2 – Flat sheets, Category 3 Type A.
- Cemintel Rigid Air Barrier is sealed on the face and edges using Cemintel's proven Ceminseal® embedded micro waterblock technology which repels water, preventing water penetrating into the panel and hence providing a durable sheet which will not rot, swell or warp when correctly installed.
- By protecting against wind and rain, it allows work to be carried on inside the building prior to the cladding being installed.
- Being fibre cement, Cemintel Rigid Air Barrier may be used where a non-combustible material is required by the NCC.
- The panels do not have sharp edges. The square edges are suitable for accepting tape to form an air seal and are available in a 1200x3000mm size (Note: custom sizes can be supplied subject to minimum order quantities – refer to Cemintel).
- Nominal Weight is 10kg/m².

Comprehensive Technical Datasheets can be downloaded from cemintel.com.au.

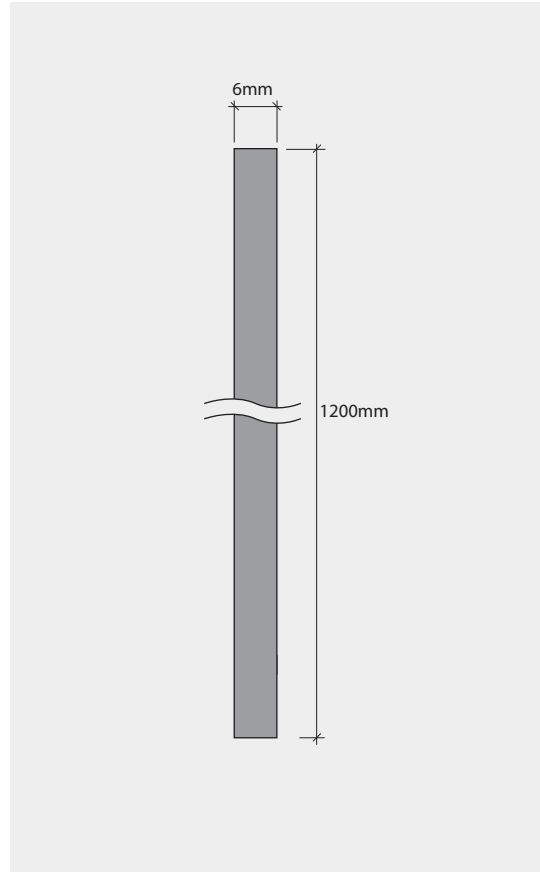

Cemintel Rigid Air Barrier

Product	Width (mm)	Length (mm)	Thickness (mm)	Product Code
Cemintel Rigid Air Barrier	1200	3000	6	170076

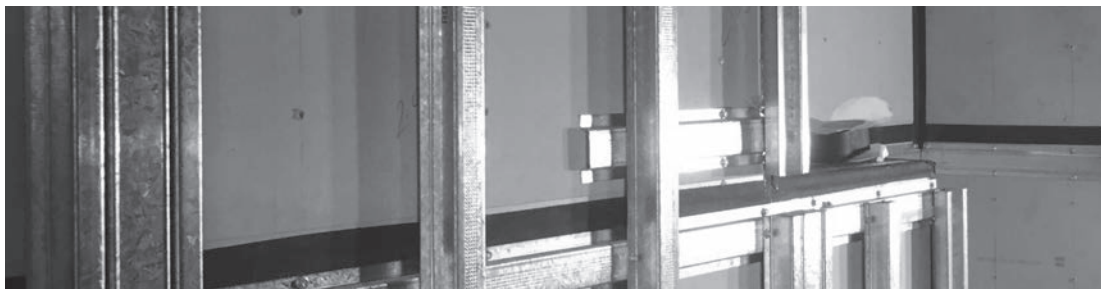



03

SYSTEM OVERVIEW

03

SYSTEM OVERVIEW

Air Barriers

Air barriers are an integral component of a pressure equalised façade system. Pressure equalised systems consist of a cladding or rainscreen installed with a ventilated cavity, and form an effective method of weatherproofing buildings.

Equivalent air pressure within the cavity to the exterior, introduced by appropriate vents and cavity baffles, can lower the pressure differential across the cladding. This differential is a pressure that can drive water through an opening in the rainscreen cladding and bridge the cavity. A low pressure differential means less chance of water crossing the cavity to reach other building elements (i.e., Rigid Air Barrier and framing). Testing carried out to AS/NZS 4284 demonstrated that water ingress is limited and present only at the back face of the cladding. The cavity then serves as a channel to return water to the outside of the building and permit air flow to promote drying.

Cemintel Rigid Air Barrier can be installed either horizontally or vertically across the frame. A flexible tape is applied continuously across joints to limit air penetration.

Any flashings should be fixed over the top of the air barrier and taped.

Cemintel provides a large range of cladding products suitable to be installed with an air barrier and an associated cavity. It is critical that the cladding and air barrier must be installed correctly as they are essential elements of a pressure equalised system. Air barriers must be effectively sealed at all perimeters, openings and joints.

Benefits of Cemintel Rigid Air Barrier

- Vapour permeable.
- No additional caulking required compared to galvanised sheet back pan systems.
- No sharp edges.
- Easy to cut on site.
- Not susceptible to corrosion.

Cemintel Rigid Air Barrier

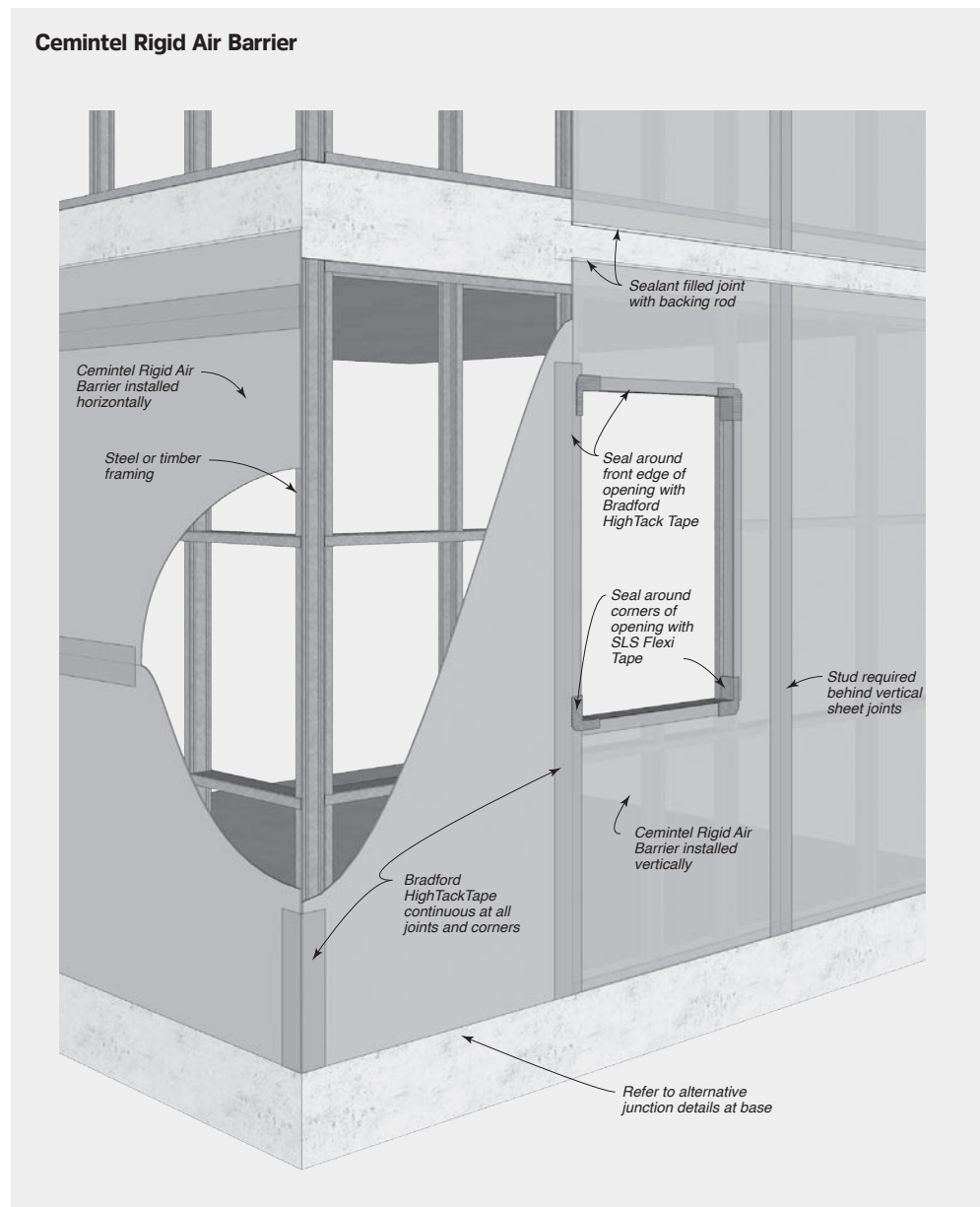

SYSTEM OVERVIEW



Applications

The air barrier system in this guide is suitable for use with timber or steel framing. They are not designed for fixing to masonry.

The Cemintel Rigid Air Barrier sheeting has been tested as part of a pressure equalised wall system and assessed to have an ultimate limit state capacity of +/- 7kPa. A negative value is a suction pressure.

Cemintel's Rigid Air Barrier can be used on walls behind a façade or exposed ceiling system (contact

Cemintel for ceiling applications). The sheets may be orientated along or across the framing members.

Due to the limited durability of some system components, the Cemintel Rigid Air Barrier systems are not recommended for use with rain screens that have open joints between panels.



TABLE 3.01 PRODUCT PERFORMANCE

Product	Maximum Design Wind Pressures	Water Barrier AS/NZS 4201.4	Vapour Permeance ASTM E96	Weather exposure limit prior to cladding
Cemintel Rigid Air Barrier	+/- 7.0kPa (ultimate) +/- 2.5kPa (service)	N/A	0.25 µg/N.s	6 months (panel) 2 months (tape)

A large, stylized graphic of the number '04' in white, set against a dark blue background. The '0' is a simple circle, and the '4' is composed of several geometric shapes. The text 'DESIGN CONSIDERATIONS' is overlaid on the bottom part of the '0' and the top part of the '4'.

04

DESIGN CONSIDERATIONS

DESIGN CONSIDERATIONS



This section outlines some important areas for consideration in determining whether Cemintel Rigid Air barrier is suitable for the required application. The following points are not exhaustive. It is the responsibility of the Architect / building designer to ensure the design conforms to NCC requirements and other relevant building standards that may exist for that location. This guide should be read in conjunction with the NCC.

Rigid Air Barrier, fasteners and structural framing are required to resist wind loads that are specific to the building site. Additional local pressure factors may apply to the panels in accordance with AS/NZS 1170.2:2021 Structural design actions, Part 2: Wind actions.

It is recommended that the architect/building designer assigns the responsibility for the façade design to the project engineer.

Once wind loads have been determined, fastener spacings, and wall wrap/panel fixing details, may be selected from the appropriate Span Tables in the 'System Engineering' section of this manual.

It is also the responsibility of the architect/building designer to select the appropriate corrosivity category as per AS 4312, assess the amount and type of exposure to UV, wind, rain etc that the air barrier will encounter prior to the external cladding being installed, the likelihood of damage by trades etc.

Pressure Equalisation

Cavity Baffle

Used vertically at the major corners or other areas of the building where differential cavity pressures either side of the corner can occur. The baffle provides an obstruction to limit the airflow between cavities and promote pressure equalisation in each wall cavity section.

A cavity baffle solution can consist of a top hat section, Z-flashing, angle, channel, a backing rod and sealant, and/or self-adhesive expanding foam tape, that will bridge and close the cavity width or gaps between the corner sub-framing and air barrier layer. The baffle shall be suitable for the project design differential pressures. As required, use compatible sealants to close of any gaps between the baffle section and the air barrier layer, cladding and sub-framing.

Control Joints

Vertical Control Joints

When installing Rigid Air Barrier, vertical control joints should be aligned with vertical movement control joints provided in the framing and at junctions of different framing materials.

Horizontal Control Joints

A horizontal control joint is required at every floor junction to accommodate deflection. The magnitude of the deflection must be verified by the project engineer. Refer to 'Construction Drawings and Details' section.

Panel Layout

Panels can be in a vertical or horizontal orientation. Span tables for both vertical and horizontal installations are provided in the 'System Engineering Details' section.

The thickness of the Rigid Air Barrier, as well as the depth of the cavity between the external façade must be considered when determining the depth of window and door reveals.

Structural

Framing and Substrate Options

For timber and steel framing, design shall be in accordance with the following standards:

- AS 1684 – Residential Timber-Framed Construction.
- AS/NZS 4600 – Cold-Formed Steel Structures.

AS/NZS 1170.0 Table C1 suggests that support framing be designed for a maximum deflection of span/250.

Structural Bracing

Cemintel Rigid Air Barrier may be used as wall bracing when used on loadbearing timber and steel framing. Contact Cemintel for further information. Areas of sheet bracing that have been assessed as suitable to perform as a rigid air barrier may be used in conjunction with Cemintel Rigid Air Barrier, taking care to ensure an effective seal is applied across the different materials.

Termite Management

There is a wide variety of methods for managing termite entry to buildings, and selecting the appropriate method for any structure depends on specific risk factors and the form of construction.

Refer to your local pest management service, the NCC, AS 3660: Termite Management and your local building authorities for more information about the requirements for the design of a suitable termite management system.

04

DESIGN CONSIDERATIONS

Durability

Cemintel Rigid Air Barrier is strong and durable, making it an excellent choice for applications subject to relatively higher wind loads and for projects that are left unclad for extended periods that may require resistance to prevent degradation / damage during construction.

The panels, and other components selected with regards to corrosion zone information, may be exposed to the weather for up to six months before being enclosed with the façade system. The tape should not be exposed to UV for more than 6 weeks.

Moisture Management**Condensation Management**

Condensation is a complex problem and can occur under a variety of conditions (not just in cold and tropical climates), and can be affected by the local climate, the building use, the system R-value, and the degree of ventilation.

Where required, a vapour impermeable wall wrap may be added to the façade system, located outside the Rigid Air Barrier, or as appropriate for the design. The wall wrap must have a high water barrier rating and meet the requirements of AS/NZS 4200.1 Pliable building membranes and underlays – Installation requirements. The external wall wrap must be sealed to maintain vapour performance and draught proofing effectiveness, and be installed in accordance with the manufacturer's instructions..

It is recommended that designers undertake a condensation risk analysis as part of the building design. Additional literature on this subject is available from CSIRO/BRANZ/ASHRAE/ACB.

Extreme Climate Conditions**Corrosive Zones**

Consideration needs to be made regarding the impact of climate conditions on system components such as fasteners and metal components.

Corrosivity zones are detailed in AS 4312. In C4 corrosivity zones, fixings must be Class 4 or stainless steel.

The building designer is responsible for assessing the site in accordance with the standard and local conditions. Responsibility for the choice of fasteners in corrosive environments lies with the building designer.

Other Design Considerations**Services**

Any penetrations formed must be considered in the framing design and effectively sealed to maintain the pressure equalisation of the cavity and accommodate building movements. Methods of sealing penetrations are given in the 'Construction Drawings and Details' section.

Renovations

When undertaking building renovations, remove all cladding, wall wrap and insulation from the original wall framing. Ensure the condition of the framing is assessed and approved by the project engineer as in accordance with current requirements and is as true and as plumb as possible (within accepted industry tolerances of 5mm over 3000mm).

05

COMPONENTS + ACCESSORIES











05

COMPONENTS + ACCESSORIES

Cemintel Rigid Air Barrier

Product	Width (mm)	Length (mm)	Thickness (mm)	Product Code
Cemintel Rigid Air Barrier	1200	3000	6	170076

Product/Accessories/Tools for Installing Cemintel Rigid Air Barrier

Other Accessories	Description	Size	Quantity	Product Code
NAILS (FOR TIMBER)				
	Machine driven nails for fixing Cemintel Rigid Air Barrier to timber framing 2.5 x 50 Ring HDG – Galvanised (C3) 2.5 x 50 Ring SS – Stainless Steel (C4) 2.5 x 50 Screw SS – Stainless Steel (C4)	2.5 x 50mm 2.5 x 50mm 2.5 x 50mm	Supplied by others	
SCREWS (FOR STEEL)				
	Screws for fixing Cemintel Rigid Air Barrier to steel framing Buildex Fibretek 25mm – Self drilling, CSK self-embedding head, phillips drive Class 4 (C4). Allowable steel framing thickness 0.50mm BMT minimum and 1.6mm BMT maximum.	10-18 x 25mm (M4.8 x 25mm)	1000 per box	125651
	Enviroseal Hightack Tape – used to seal vertical and horizontal sheet joints around openings, corners and at flashings. Black, single sided, aggressive adhesive tape with a high initial grab and flexible carrier.	60mm x 25m	1 roll	160950
	Enviroseal SLS Flexi Tape – used to tape corners of openings.	60mm x 5m	1 roll	124872
	Sealant – Sealant is used to seal the Rigid Air Barrier to the framing and parts of the structure to form an air seal. This sealant is compatible with many materials; including steel, concrete and fibre cement. Also used to seal control joints, junctions, penetrations etc.	Sikaflex Pro 310ml tube (GREY)	1 each	11378
	Sealant Bond Breaker tape – used behind sealant to prevent 3-sided bonding.	48mm x 3mm x 25m	1 each	13172
	Backing Rod – for sealant backing – used to enable correct filling of joints with sealant. Also used as an air seal at window openings and construction junctions. The diameter of backing rod must be appropriate for the width of the gap being filled. 10mm polyethylene foam bead for use with sealants.	10mm diameter x 50m roll	1 each	11177
	Flashings and Cappings – flashings are to be designed and installed in accordance with SAA-HB39 1997 and good building practice.		Supplied by others	
Tools				
	Makita Plunge Saw Kit (1300W) includes 1400mm guide rail and bonus 165mm fibre cement saw blade – excellent for cutting cement based sheets.	165mm	1	165485
	Makita 165mm Fibre Cement Saw Blade – ideal for use with the Makita Plunge saw and other 165mm circular saws fitted with vacuum extraction systems.	165mm x 20 x 4T	1	165486
	FESTOOL DSC-AGP 125 – Diamond Blade Cutting and Grinding Tool. Used to provide neat and accurate bevelled edges.	125mm	1	107207
	FESTOOL TS 55 EBQ Plunge Cut Saw – with 1400mm Guide Rail. Precise plunge cuts in materials up to 55mm thick.	160mm	1	121400
	FESTOOL Diamond Tipped Blade for TS 55 – for cutting all fibre cement sheet products.	160mm	1	112647

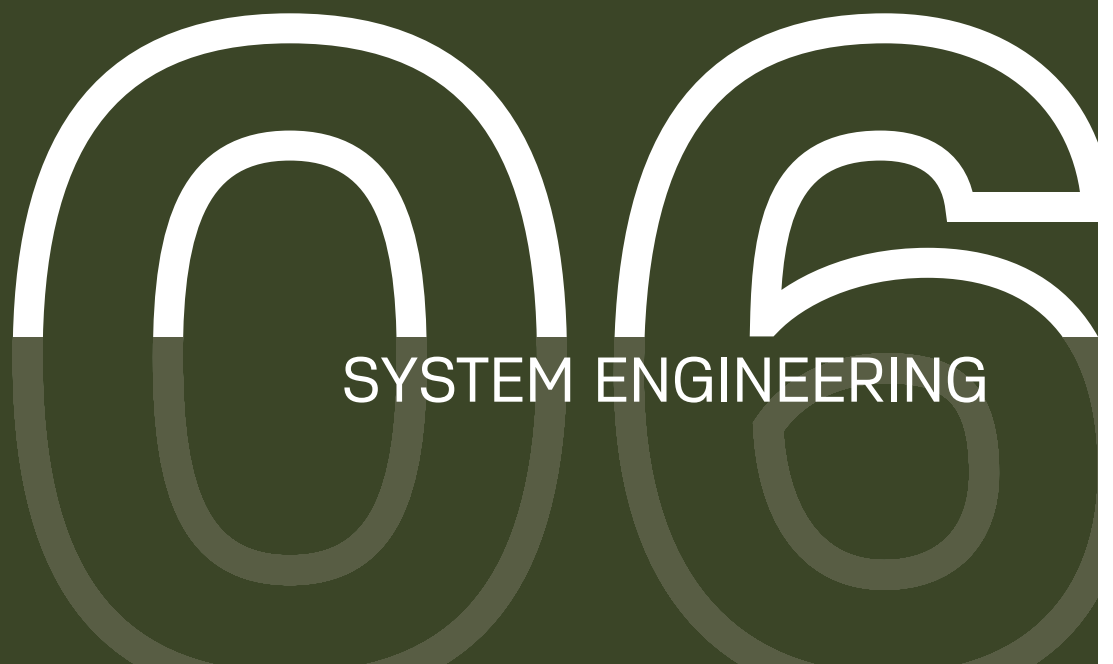

06

SYSTEM ENGINEERING



SYSTEM ENGINEERING

Design, Detailing And Performance Responsibilities

The Cemintel Rigid Air Barrier system detailed in this guide are designed to act as one component of an exterior wall system. The functional requirements of exterior walls may include weather resistance, sound rating, fire rating, spread of fire, thermal insulation, loading resistance, amongst others, that are not considered in this guide. Compliance with these items are within the role of various project design specialists.

Project Consultants (Structure, Fire, Acoustics, etc.)

These consultants are typically responsible for the following:

- Opinions on expected laboratory performance of wall configurations that vary from actual test configuration, such as substitution products and Components.
- Judgements about expected field performance using laboratory test reports and practical experience.
- Design, specification and certification of structural, fire, acoustic, durability, weather tightness and any other required performance criteria for individual projects.

This involves the design and selection of building elements, such as wall and floors and their integration into the building considering the following:

- Interface of different building elements and to the structure / substrate.
- Wall and floor junctions.
- Penetrations.
- Flashing design.
- Room / building geometry.
- Acoustic and water penetration field-testing.

Project Certifier and/or Builder

These professionals are typically responsible for:

- Identifying the performance requirements for the project in accordance with the NCC and clearly communicating this to the relevant parties.
- Applicability of any performance characteristics supplied by Cemintel including test and opinions for the project.
- The project consultant's responsibilities detailed above if they are not appointed.

Cemintel does not provide consulting services.

Cemintel only provides information that has been prepared by others and therefore shall not be considered experts in the field. Any party using the information contained in this guide or supplied by Cemintel in the course of a project must satisfy themselves that it is true, current and appropriate for the application, consequently accepting responsibility for its use.

It is the responsibility of the architectural designer and engineering parties to ensure that the details in this design guide are appropriate for the intended application.

The recommendations in this guide are formulated along the lines of good building practice, but are not intended to be an exhaustive statement of all relevant data.

Cemintel is not responsible for the performance of constructed walls, including field performance, and does not interpret or make judgements about performance requirements in the NCC.



SYSTEM ENGINEERING

FIGURE 6.02 SHEET FIXING – VERTICAL SHEETING – STEEL FRAMING. **NON-LOADBEARING** FRAMING SHOWN.

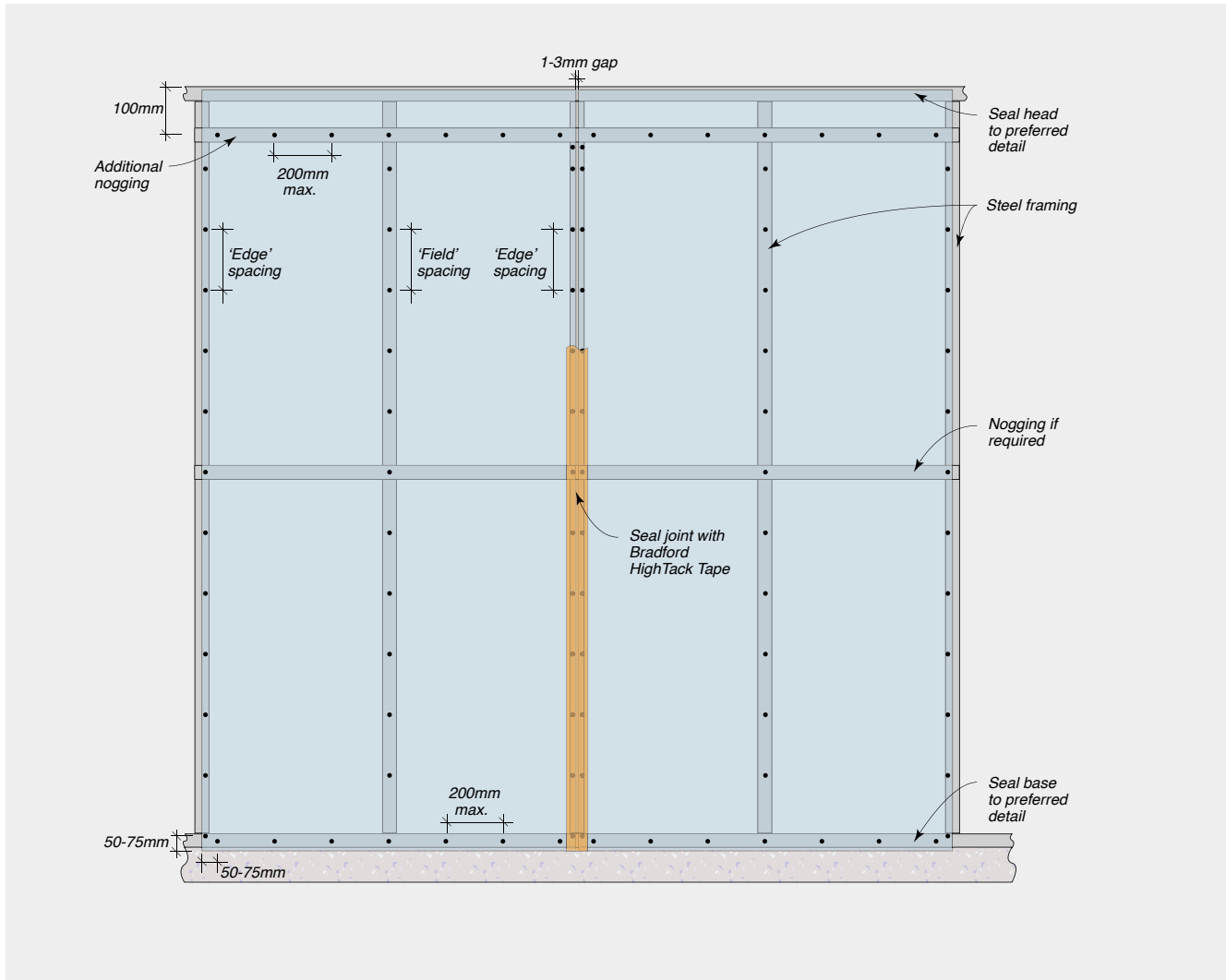

Timber and Steel Framing

TABLE 6.01 VERTICAL SHEETING - SPAN TABLE

Design ULS Wind Pressure (kPa)	Maximum Stud Centres (mm)	Fixing Centres (mm)	
		Field	Edge
1	600	300	400
2	450	200	400
3	350	175	400
4	300	150	375
5	250	125	325
5.5	250	125	325

NOTE: Braced walls will require a closer fastener spacing and stud spacing. Contact CSR Designlink for assistance.

SYSTEM ENGINEERING



Span Tables / Wind Loads & Fastener Spacings for Cemintel Rigid Air Barrier

FIGURE 6.03 SHEET FIXING – HORIZONTAL SHEETING* – TIMBER OR STEEL FRAMING. **LOADBEARING** FRAMING SHOWN.

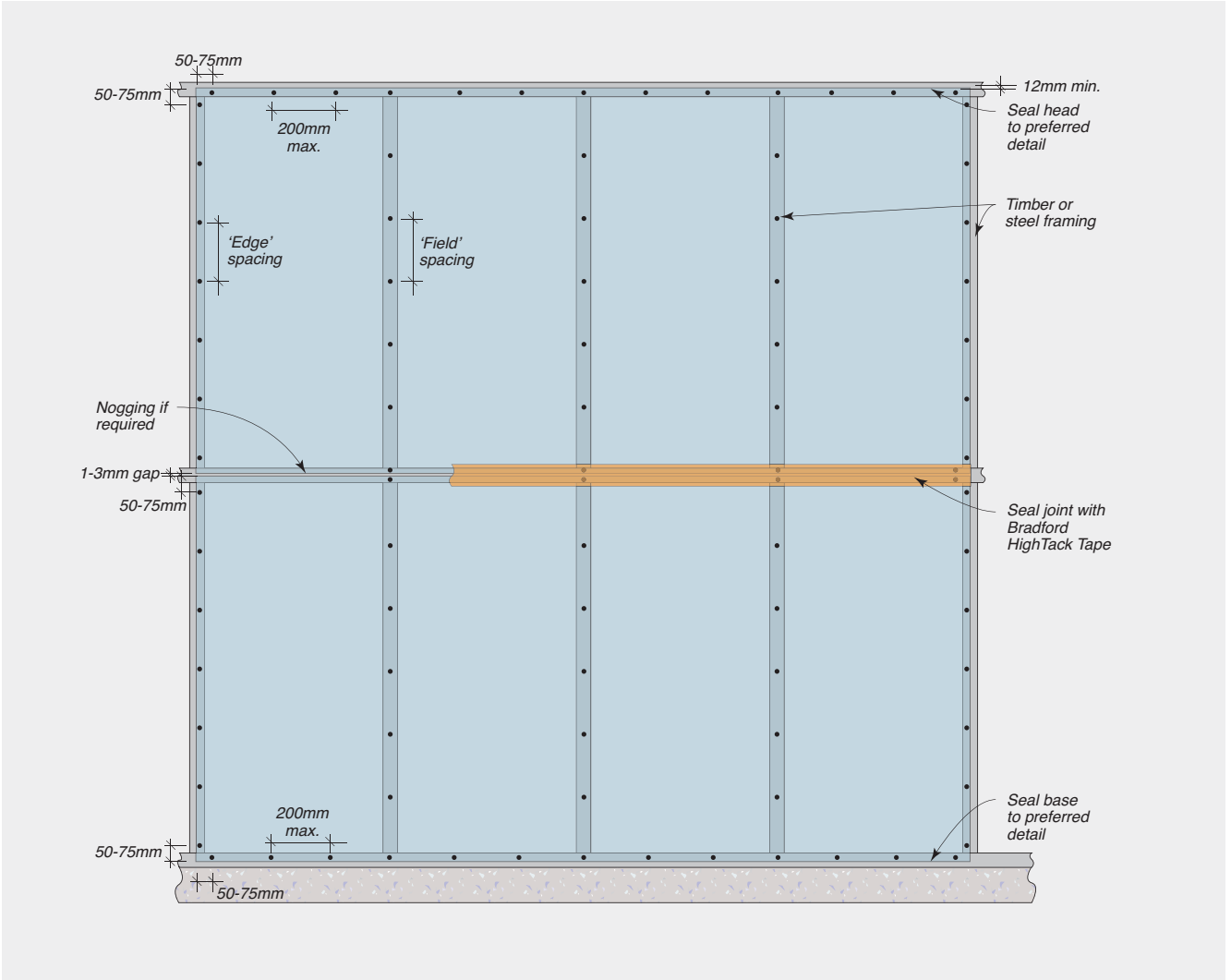

* Sheets installed with long edges parallel to the base.



SYSTEM ENGINEERING

FIGURE 6.04 SHEET FIXING - HORIZONTAL SHEETING* - STEEL FRAMING. **NON-LOADBEARING** FRAMING SHOWN.

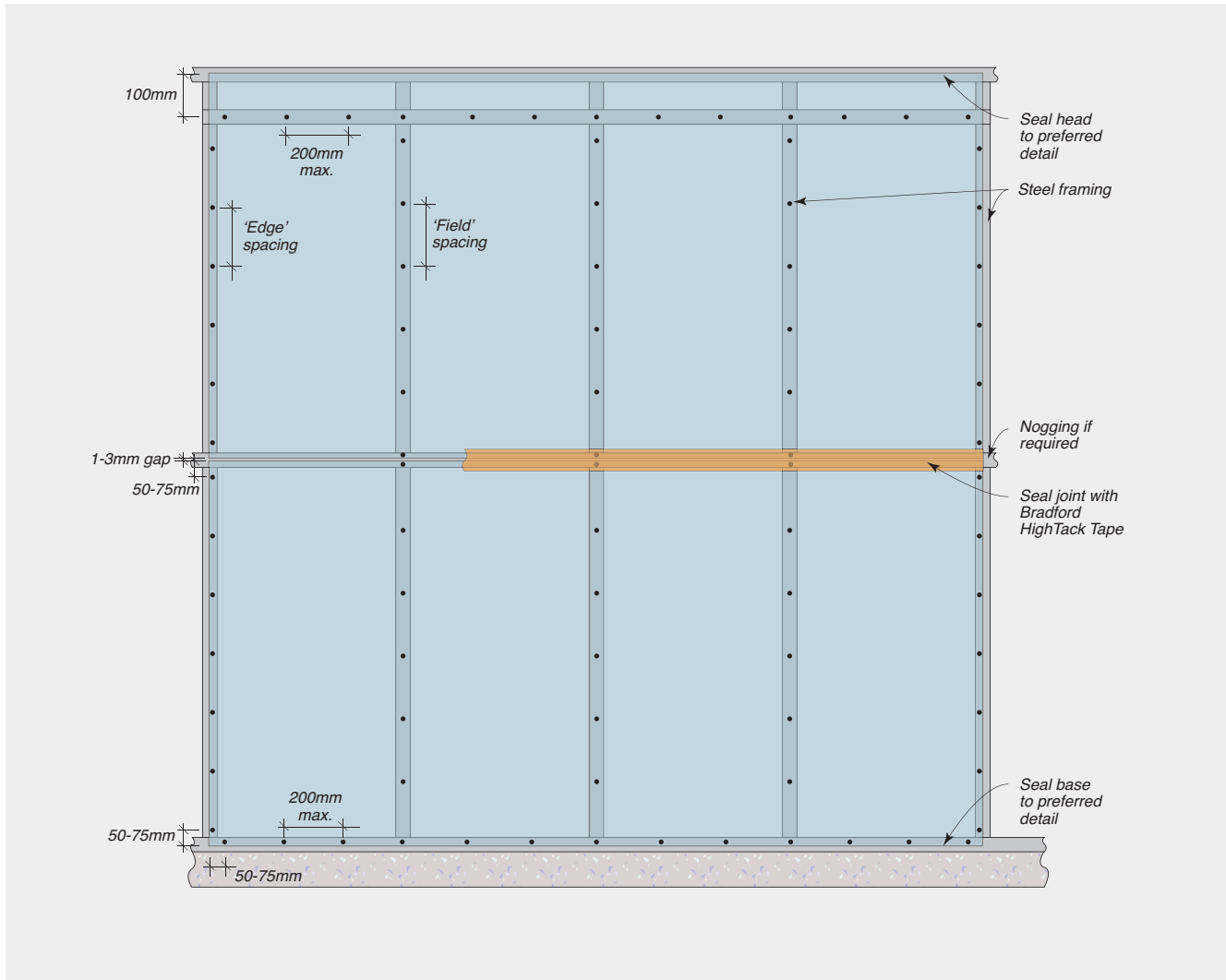

* Sheets installed with long edges parallel to the base.

Timber and Steel Framing

TABLE 6.02 HORIZONTAL SHEETING - SPAN TABLE

Design ULS Wind Pressure (kPa)	Maximum Stud Centres (mm)	Fixing Centres (mm)	
		Field	Edge
1	600	250	400
2	550	175	400
3	450	125	350
4	350	125	300
5	350	100	275
6	300	100	250
7	300	75	225

NOTE: Braced walls will require a closer fastener spacing and stud spacing. Contact CSR Designlink for assistance.

SYSTEM ENGINEERING



Timber and Steel Framing – RESIDENTIAL – NCC Volume Two Class 1 and 10 buildings

TABLE 6.03 VERTICAL SHEETING – SPAN TABLE

AS 4055 Wind Classification	GENERAL ZONE			CORNER ZONE		
	Maximum Stud Centres (mm)	Fixing Centres (mm)		Maximum Stud Centres (mm)	Fixing Centres (mm)	
		Field	Edge		Field	Edge
N1	600	300	400	600	300	400
N2	600	300	400	550	275	400
N3/C1	600	300	400	450	200	400
N4/C2	500	250	400	375	175	400
N5/C3	400	200	400	300	150	375
N6/C4	350	175	400	250	125	300

NOTE: Braced walls will require a closer fastener spacing and stud spacing. Contact CSR Designlink for assistance.

GENERAL ZONES – Wall areas greater than 1200mm from an External Building Corner for Buildings satisfying the AS 4055 geometry limits.

CORNER ZONES – Wall areas less than 1200mm from an External Building Corner for Buildings satisfying the AS 4055 geometry limits.

Loads based on AS 4055 with Factored external pressure coefficient, $k_{l,Cp,e} = -1.3$ & ± 0.7

Timber and Steel Framing – RESIDENTIAL – NCC Volume Two Class 1 and 10 buildings

TABLE 6.04 HORIZONTAL SHEETING – SPAN TABLE

AS 4055 Wind Classification	GENERAL ZONE			CORNER ZONE		
	Maximum Stud Centres (mm)	Fixing Centres (mm)		Maximum Stud Centres (mm)	Fixing Centres (mm)	
		Field	Edge		Field	Edge
N1	600	300	400	600	250	400
N2	600	300	400	600	225	400
N3/C1	600	225	400	550	175	400
N4/C2	600	200	400	450	125	350
N5/C3	500	150	400	375	100	300
N6/C4	450	125	350	325	100	250

NOTE: Braced walls will require a closer fastener spacing and stud spacing. Contact CSR Designlink for assistance.

GENERAL ZONES – Wall areas greater than 1200mm from an External Building Corner for Buildings satisfying the AS 4055 geometry limits.

CORNER ZONES – Wall areas less than 1200mm from an External Building Corner for Buildings satisfying the AS 4055 geometry limits.

Loads based on AS 4055 with Factored external pressure coefficient, $k_{l,Cp,e} = -1.3$ & ± 0.7

07

INSTALLATION

CHECKLIST – Prior to Installation

The following pre-install checklist may assist with ensuring you have the best possible outcome when installing air barriers.

- Ensure substrate is structurally sound and square. Pack to straighten if necessary (timber frames as per AS 1684, steel frames as per AS/NZS 4600). Check with certifier regarding packing materials.
- Confirm bracing is in place, if required. Bracing may have an impact on cladding alignment that should be considered.
- Ensure studs and noggings are correctly located and of the appropriate thickness.
- Remove any excess concrete that may foul the Rigid Air Barrier line, particularly at steps in slabs.
- Ensure there is adequate ground clearance to the bottom edge of the Cemintel Rigid Air Barrier panels as per regulatory requirements (including for water/rain runoff and termite management). These can vary from 50-150mm depending on type of ground and termite requirements.



Check quality and quantity of panels and components before installing. If there is any sign of damage or visible defects in panels DO NOT INSTALL. Contact Cemintel to address any issues.

Installation of Cemintel Rigid Air Barrier™

The Cemintel Rigid Air Barrier may be installed horizontally or vertically across the frame. An appropriate panel fixing layout should be selected for the project design wind pressure and frame spacing. Panels must be fixed in accordance with the tables set out in the Cemintel Rigid Air Barrier Design & Installation Guide.

Panels are fixed to timber framing using nails to steel framing using screws. A small joint (maximum 3mm) is acceptable. Joints are taped using HighTack tape to form an air barrier. Similarly, all corners, penetrations and junctions are sealed with HighTack tape or with flexible sealant.

All flashings should be fixed over the top of the Rigid Air Barrier and taped with HighTack tape.

Procedure for Horizontal or Vertical Sheet Application

- 1 Cut sheets to ensure vertical joints are supported by studs and horizontal joints are backed by noggings.
- 2 Position sheets (refer to Head & Base details in 'Construction Details' section). Screw fix (to steel frame) or nail (to timber frame) at the detailed fastener centres.
- 3 Install adjacent sheets.
- 4 Seal vertical joints, horizontal joints, and corners with HighTack tape. Seal junctions and penetrations with Sikaflex Pro flexible sealant.
- 5 Seal any openings in head, sill and jamb framing with HighTack tape.
- 6 Apply SLS FlexiTape to corners of window and door openings.

FIGURE 7.01 TYPICAL RIGID AIR BARRIER INSTALLATION

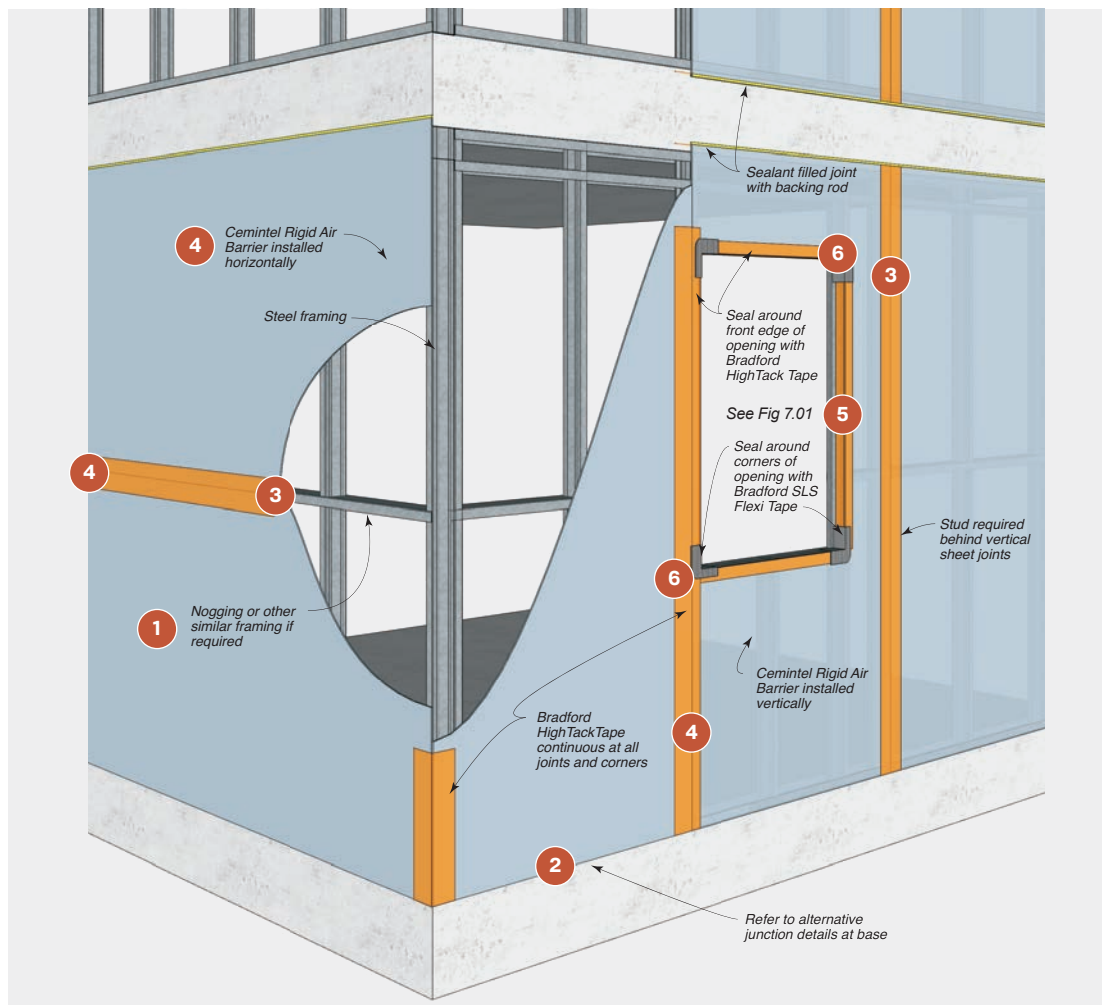
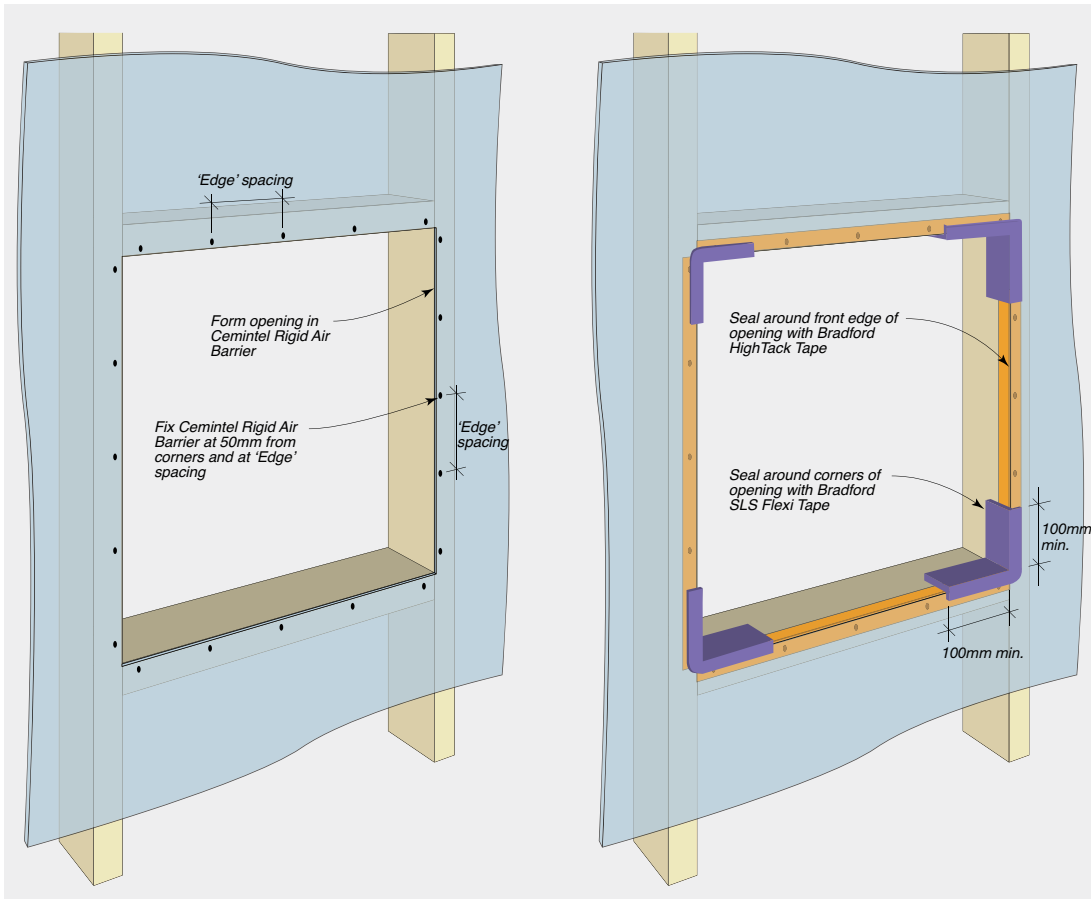

FIGURE 7.02 TREATMENT AT WINDOW/DOOR OPENINGS – RIGID AIR BARRIER



CONSTRUCTION
DRAWINGS + DETAILS

CONSTRUCTION DRAWINGS AND DETAILS



Note: Drawings are interchangeable for timber or steel substrates with the exception of the fasteners.

Drawings Index

SECTION	DESCRIPTION	FIGURE REFERENCE	PAGE NUMBER
RIGID AIR BARRIER			
Overview	Typical Installation Overview – Rigid Air Barrier	8.01	26
	Junctions at Soffit, Base and Horizontal Sheet Joint – Rigid Air Barrier	8.02	26
Head Detail	Inline Slab – Junction at Soffit Overhanging Framing	8.03	27
	Recessed – Junction at Soffit with Deformable Flashing – Rigid Air Barrier	8.04	27
Base Detail	Junction at Base – Overhanging Framing – Rigid Air Barrier	8.05	27
	Junction at Base – Overhanging Slab	8.06	27
Corner	External Corner – Rigid Air Barrier	8.07	28
	Internal Corner – Rigid Air Barrier	8.08	28
Junction Details	Vertical Junction – Rigid Air Barrier	8.09	28
	Junctions at Intermediate Level – Steel Framing – Rigid Air Barrier	8.10	29
	Junction at Intermediate Level – Timber Framing – Rigid Air Barrier	8.11	29
Window Details	Treatment at Window/Door Openings – Rigid Air Barrier	8.12	30
Drain Details	Junctions at Drain Penetration – Rigid Air Barrier – Timber or Steel Framing	8.13	30
Parapet Details	Installation at Parapet Junctions – Rigid Air Barrier – Timber or Steel Framing	8.14	30



CONSTRUCTION DRAWINGS AND DETAILS

RIGID AIR BARRIER

Overview

FIGURE 8.01 TYPICAL INSTALLATION OVERVIEW – RIGID AIR BARRIER

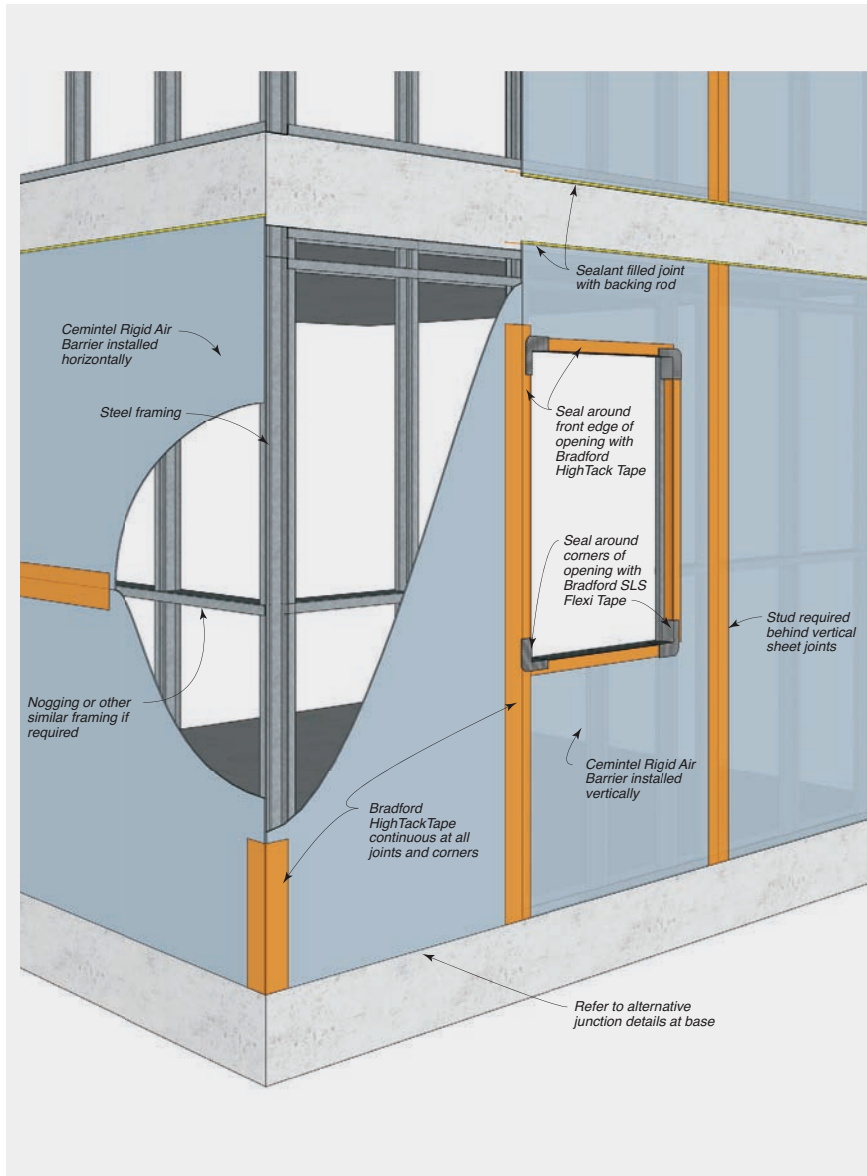
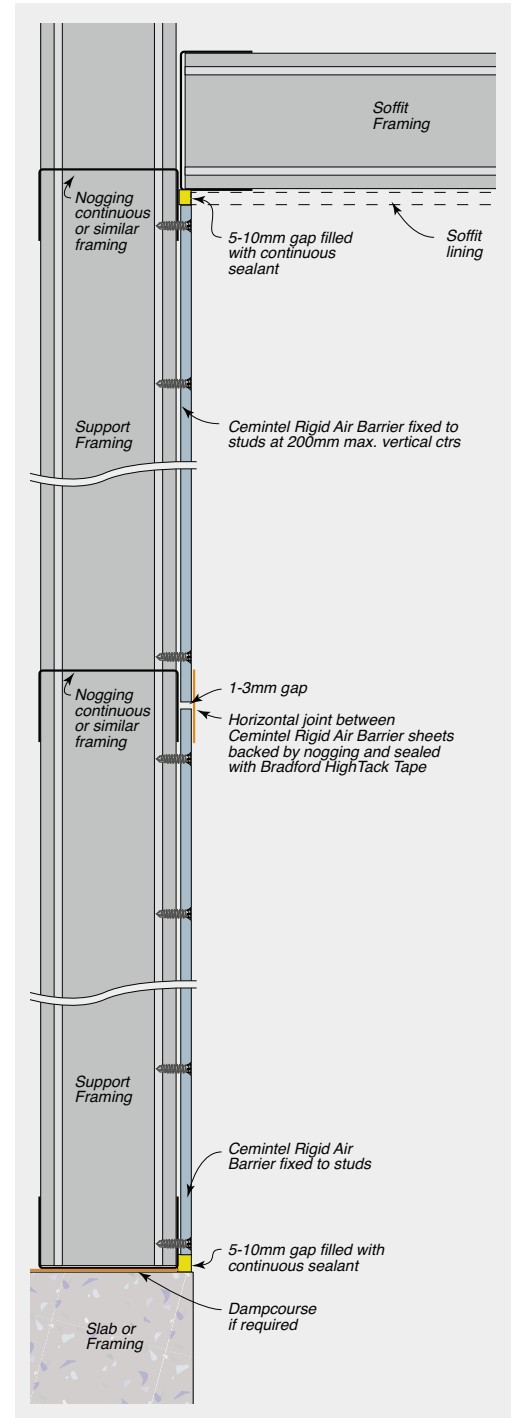

FIGURE 8.02 JUNCTIONS AT SOFFIT, BASE AND HORIZONTAL SHEET JOINT – RIGID AIR BARRIER



CONSTRUCTION DRAWINGS AND DETAILS



Note: Drawings are interchangeable for timber or steel substrates with the exception of the fasteners.

Head Detail

FIGURE 8.03 INLINE SLAB – JUNCTION AT SOFFIT OVERHANGING FRAMING

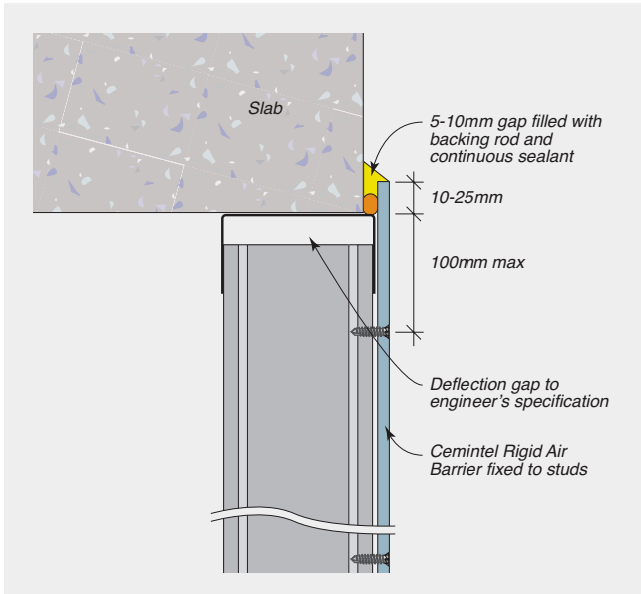
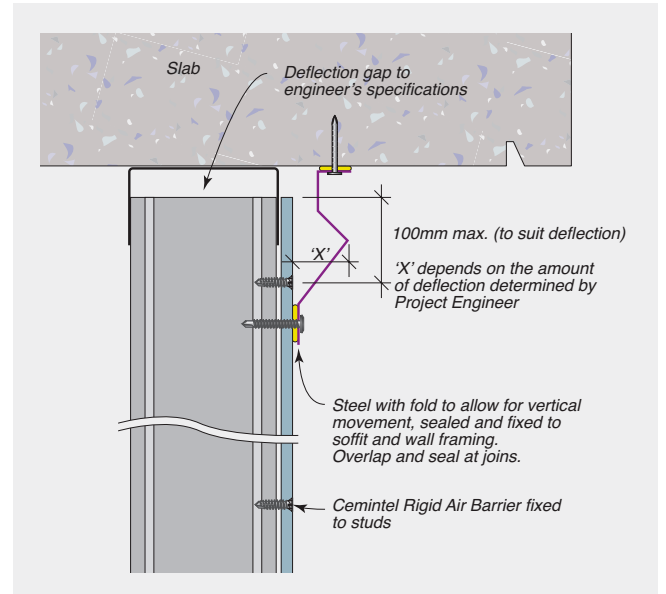

FIGURE 8.04 RECESSED – JUNCTION AT SOFFIT WITH DEFORMABLE FLASHING – RIGID AIR BARRIER



Base Detail

FIGURE 8.05 JUNCTION AT BASE – OVERHANGING FRAMING – RIGID AIR BARRIER

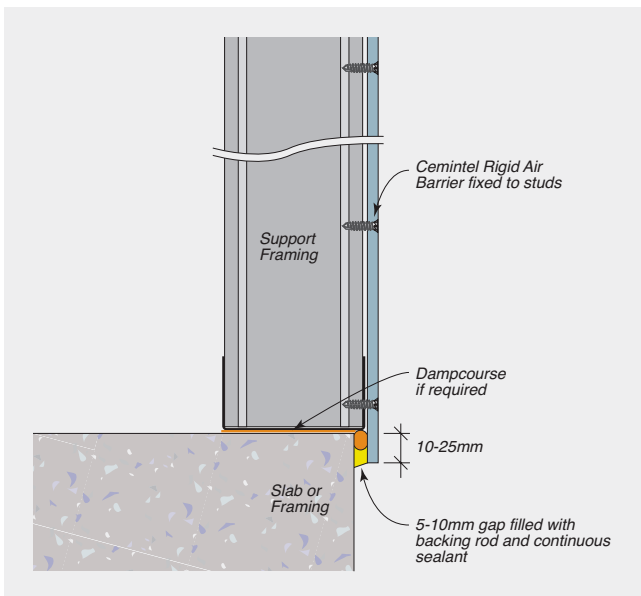
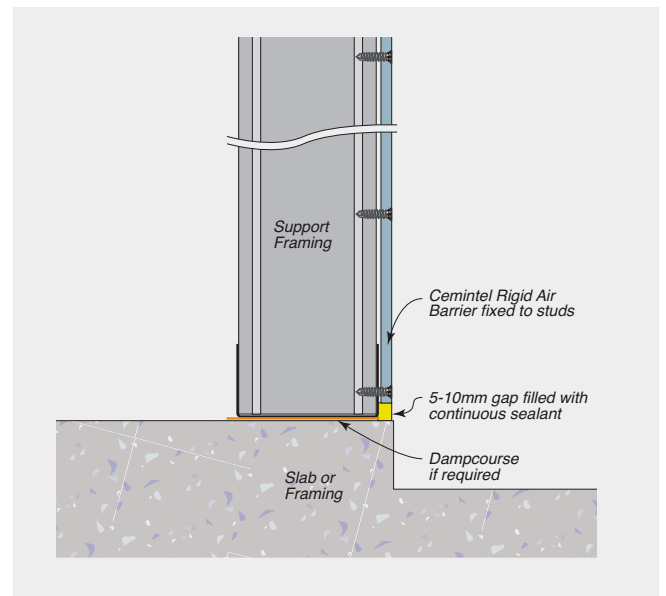

FIGURE 8.06 JUNCTION AT BASE – OVERHANGING SLAB





CONSTRUCTION DRAWINGS AND DETAILS

Note: Drawings are interchangeable for timber or steel substrates with the exception of the fasteners.

Corner

FIGURE 8.07 EXTERNAL CORNER – RIGID AIR BARRIER

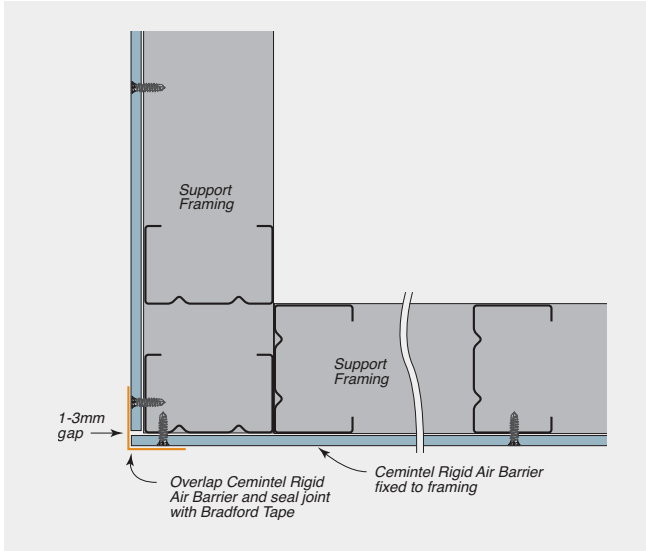
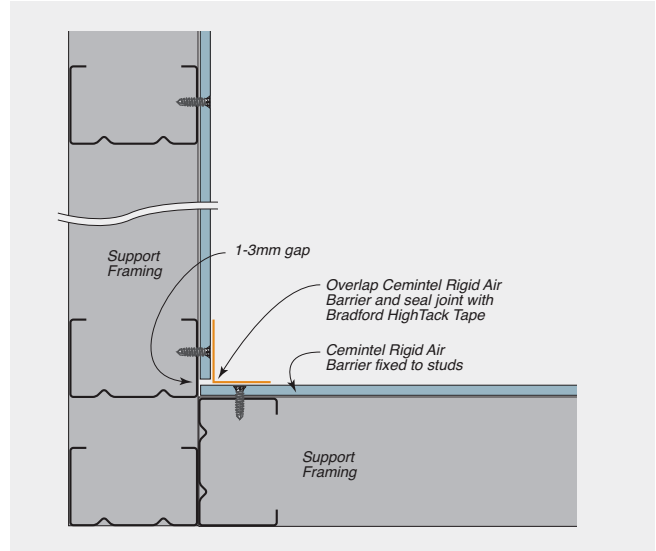
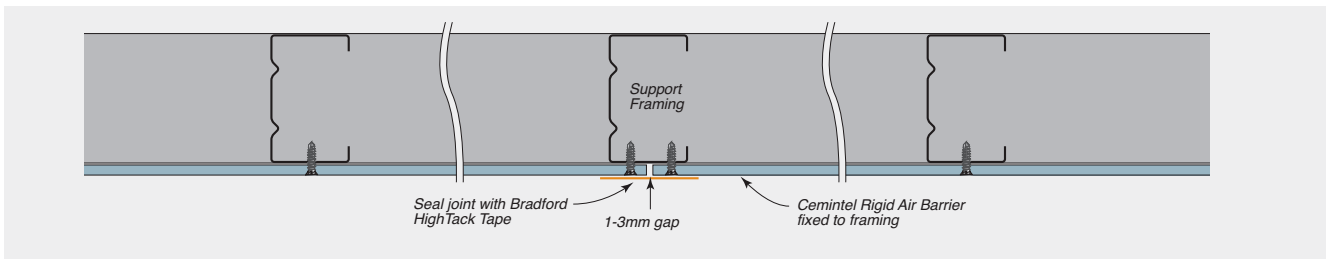

FIGURE 8.08 INTERNAL CORNER – RIGID AIR BARRIER



Junction

FIGURE 8.09 VERTICAL JUNCTION – RIGID AIR BARRIER



CONSTRUCTION DRAWINGS AND DETAILS



Note: Drawings are interchangeable for timber or steel substrates with the exception of the fasteners.

FIGURE 8.10 JUNCTION AT INTERMEDIATE LEVEL
– STEEL FRAMING – RIGID AIR BARRIER

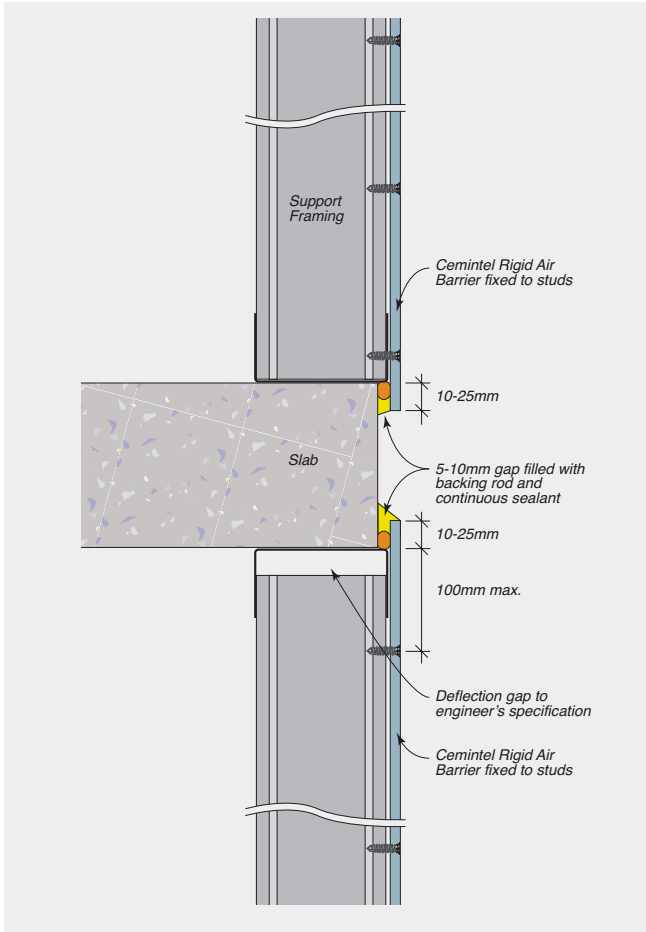
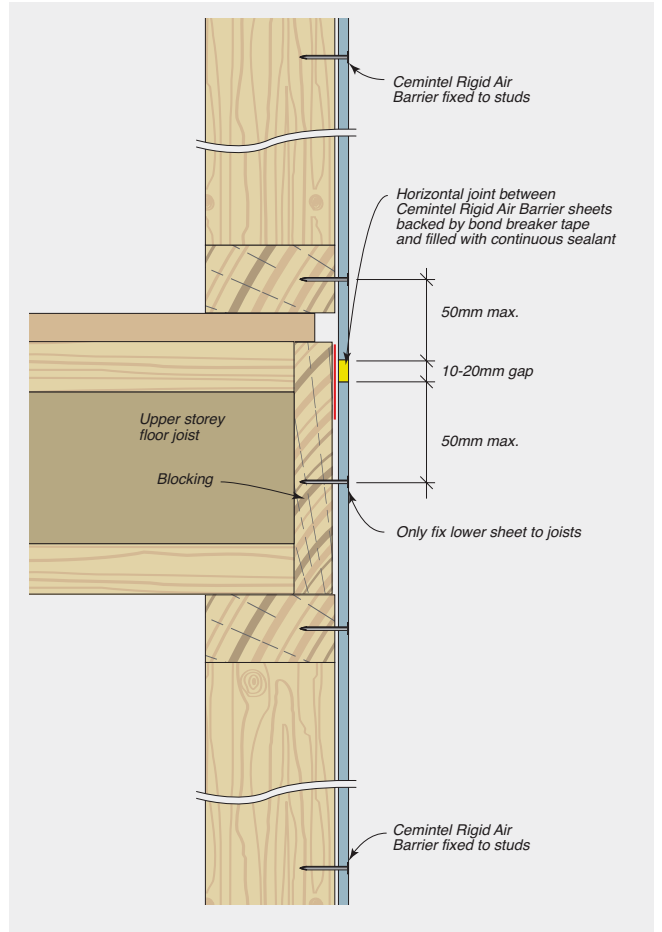

FIGURE 8.11 JUNCTIONS AT INTERMEDIATE LEVEL
– TIMBER FRAMING – RIGID AIR BARRIER





CONSTRUCTION DRAWINGS AND DETAILS

Note: Drawings are interchangeable for timber or steel substrates with the exception of the fasteners.

Window Details

FIGURE 8.12 TREATMENT AT WINDOW/DOOR OPENINGS
– RIGID AIR BARRIER

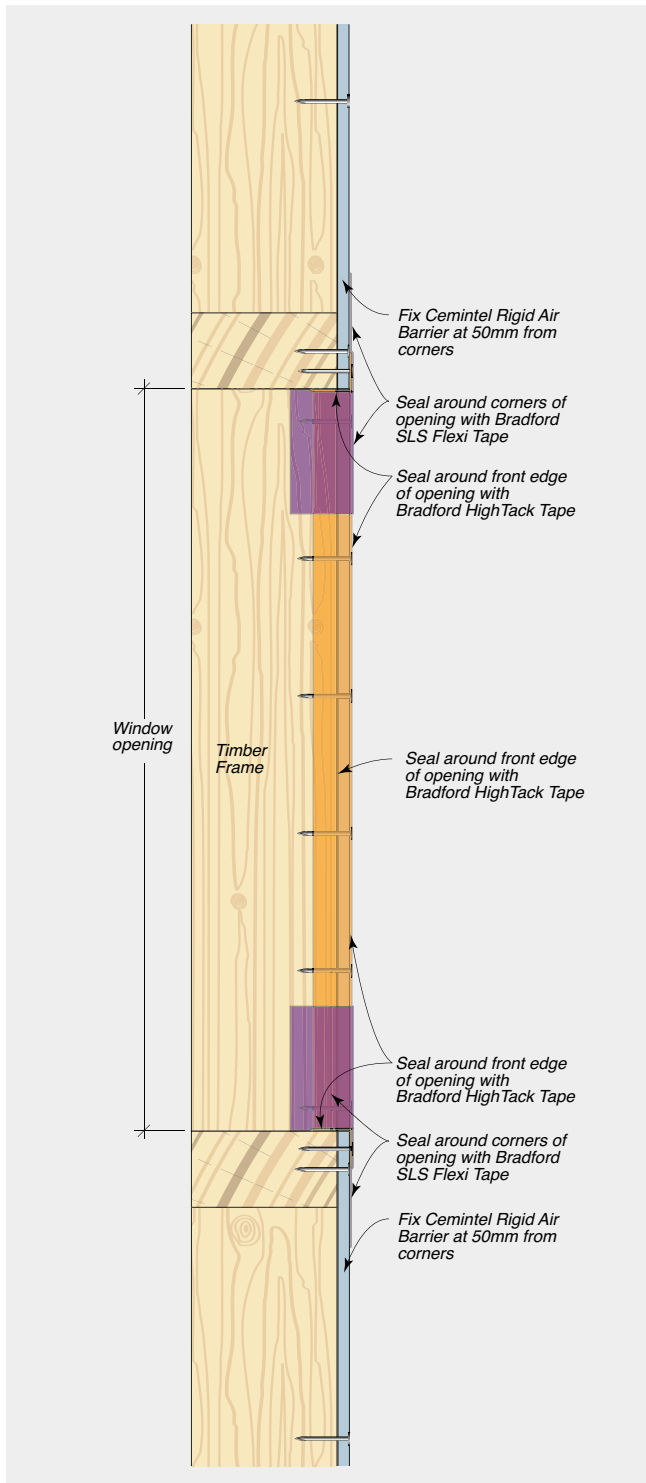

Drain Details

FIGURE 8.13 JUNCTIONS AT DRAIN PENETRATION
– RIGID AIR BARRIER – TIMBER OR STEEL FRAMING

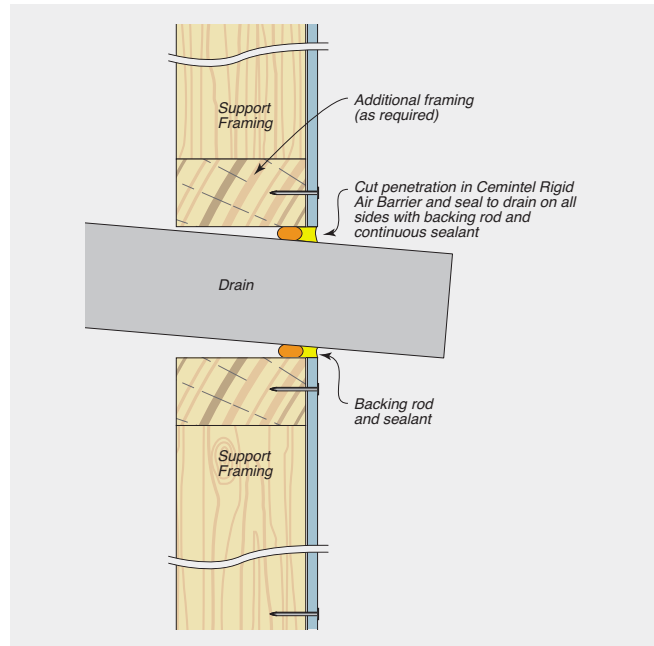

Parapet Details

FIGURE 8.14 INSTALLATION AT PARAPET JUNCTIONS
– RIGID AIR BARRIER – TIMBER OR STEEL FRAMING

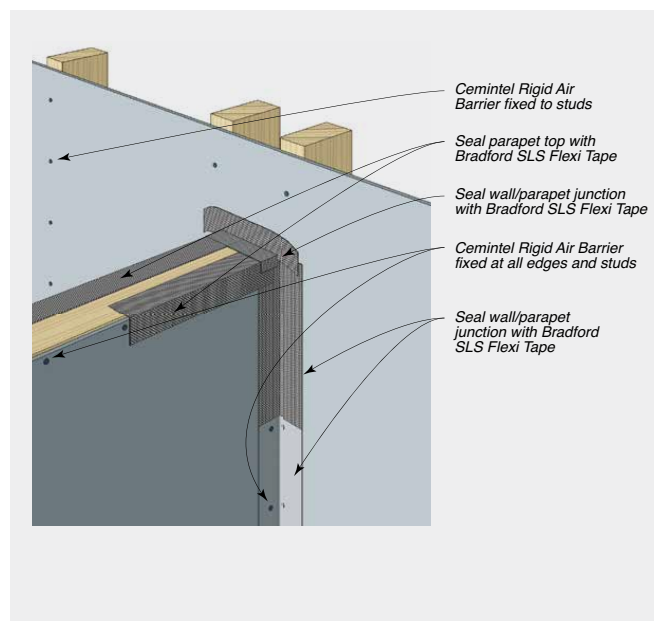



**SAFETY, HANDLING, GENERAL CARE
+ WARRANTY**



SAFETY, HANDLING, GENERAL CARE + WARRANTY



Health, Safety and Personal Protection Equipment (PPE)

Fibre Cement contain silicas that are harmful if inhaled. Protective clothing and breathing equipment should be worn when cutting products.

When cutting, drilling or grinding fibre cement panels using power tools, always ensure the work area is properly ventilated.

An approved dust mask (AS/NZS 1715 and AS/NZS 1716) and safety glasses (AS/NZS 1337) must be worn. Cemintel recommends that hearing protection also be worn.

Safety Data Sheet information is available at www.cemintel.com.au



Managing Respirable Crystalline Silica Dust

Crystalline Silica is everywhere. It is found naturally in stone, rocks, sand, gravel and clay. Sand is one of the raw materials in Fibre Cement. Respirable Crystalline Silica dust is the fine dust that's created when you use power tools to cut, drill, grind, chip or sand materials and products that contain crystalline

silica. This dust is of concern due to its size as it gets caught deep in your lungs and can cause long term damage.

IF YOU USE THE CORRECT SAFETY EQUIPMENT AND PPE, FIBRE CEMENT IS SAFE TO USE.

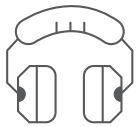

Cemintel Safety Requirements

1 - Cut Outdoors*	The ventilation outdoors is greater than that indoors, and therefore should reduce exposure.
2 - Use On-Tool Dust Extraction	Use on-tool dust extraction when using power tools to drill and cut Fibre Cement, with a vacuum that contains a HEPA M Class filter.
3 - Correct Saw and Blade	Use a plunge saw with a specifically designed Fibre Cement blade.
4 - Don't Sweep, Vacuum instead	When completing your work vacuum with a HEPA M Class filter, rather than a broom as sweeping creates more dust.
5 - Use Correct Respirator	Use a half face P1 or P2 respirator. It is essential that the respirators are Fit Tested and workers are cleanly shaven to obtain a good seal.

* Even though not recommended, indoor cutting can be completed when using an onsite cutting room with exhaust ventilation and a M class filter at a minimum, on-tool dust extraction with a vacuum with a HEPA M Class filter, a Full Face P2 respirator and conducting local occupational and static air monitoring to validate effectiveness of control measures.

Safety, Handling, and Maintenance

Storage

All Cemintel panels must be stacked flat, clear of the ground and supported at 300mm maximum centres on a level platform. Panels must be kept dry, preferably stored inside the building. Panels must be dry prior to fixing, hence if it is necessary to store outside, the product must be protected from the weather.

Handling

Prefinished products and must be treated with care during handling to avoid damage to edges, ends and prefinished surface. Panels should be carried horizontally on edge by at least two people.

Consideration should be given to planning the order of other trades that might stain or damage the panels.

Any splashings of mud, cement, mortar and the like should be removed immediately.

Warranty

The Cemintel Rigid Air Barrier panels have a product warranty of 10 years.

The full Cemintel product warranty is available for download at cemintel.com.au

Cutting

Panels should be fully supported and cut from the back using a power saw. Cemintel recommends using the Makita Plunge Cut Saw with guide rail and appropriate blade, together with the appropriate dust extraction system. All exposed cut edges **MUST BE SEALED WITH CEMINTEL EDGE SEALER TO PREVENT MOISTURE ABSORPTION.**

Mitres

It is not recommended to mitre panel edges as this can cause delamination of the face.

Penetrations

Penetrations in panels may be cut or drilled prior to installation. Cut from the back or drill from the front. Mask, prime and fill gaps with sealant in accordance with recommended methods and products.

NOTES

A large grid of small dots for taking notes, covering the majority of the page below the 'NOTES' header.

NOTES

A large grid of small dots for taking notes, covering the majority of the page below the 'NOTES' header.

NOTES

A large grid of small dots for taking notes, covering the majority of the page below the 'NOTES' header.



Our Offices

Sydney

376 Victoria Street
Wetherill Park NSW 2164

Adelaide

Lot 100 Sharp Court
Mawson Lakes SA 5095

Darwin

Cnr Stuart Highway
& Angliss Street
Berrimah NT 0828

Melbourne

277 Whitehall Street
Yarraville VIC 3013

Perth

19 Sheffield Road
Welshpool WA 6106

Brisbane

768 Boundary Road
Coopers Plains QLD 4108

Hobart

11 Farley Street
Derwent Park TAS 7009

cemintel.com.au
1300 236 468

For Design and Technical Support:
DesignLINK – 1800 621 117

Cemintel is a trading entity of CSR Building Products Limited (ACN 008 631 356).

The products referred to in this document have been manufactured by or on behalf of CSR Building Products Limited ("CSR") to comply with the National Construction Code of Australia (NCC) and any relevant Australian Standards. While any design or usage guidelines set out in this document have been prepared in good faith by CSR, they are of a general nature only and are intended to be used in conjunction with project specific design and engineering advice.

It is the responsibility of the customer to ensure that CSR's products are suitable for their chosen application, including in respect of project-specific matters such as, but not limited to structural adequacy, acoustic, fire resistance/combustibility, thermal, and weatherproofing requirements. All information relating to design/installation/application of these products is offered without warranty and no responsibility can be accepted by CSR for errors and omissions, or for any use of the relevant products not in accordance with CSR's technical literature or any other relevant industry standards. For current technical and warranty documentation relating to Cemintel's products, visit Cemintel's website at www.cemintel.com.au.