



TERRITORYTM SERIES
Internal Installation



INTRODUCTION

TABLE OF CONTENTS

01 INTRODUCTION	2	05 COMPONENTS + ACCESSORIES	13
Introduction	2	06 SYSTEM ENGINEERING	16
02 PRODUCT OVERVIEW	3	Design, Detailing and Performance	
Panel Information	4	Responsibilities	17
Colour Palette	5	07 INSTALLATION	18
03 SYSTEM OVERVIEW	6	Checklist – Prior to Installation	19
Horizontal Installation	7	Horizontal Installations	
Vertical Installation	7	Installation Set-Out	20
Applications	8	Horizontal Installation	23
Benefits of the Cemintel Territory System	8	Vertical Installation	
Product Specifications	8	Installation Set-Out	26
04 DESIGN + AESTHETIC CONSIDERATIONS	9	Vertical Installation	30
General	10	08 CONSTRUCTION DRAWINGS + DETAILS	33
Face Fixings	10	Horizontal Installation	35
Window & Door Openings	10	Vertical Installation	38
Corners	10	09 SAFETY, HANDLING, GENERAL CARE + WARRANTY	41
Coverage	10	Health, Safety and PPE	42
Control Joints	11	Safety, Handling and Maintenance	42
Structural	11	Warranty	42
Other Design Considerations	12		
Inspection, Repair and Maintenance	12		
Wash Down Process	12		

Introduction

Cemintel Territory™ is a prefinished cladding system that simulates materials such as timber, concrete, metal and brick.

Territory cladding is a 16mm thick cement bonded fibrous wood particle panel that is pressed with surface textures and finished with a high quality paint and UV coating. Panels are 3030mm in length, with an effective cover width of 455mm, and connect seamlessly into each other via a tongue and groove profile.

Territory cladding panels are supported by a proprietary concealed fixing system that enables the panels to be installed on masonry, timber and steel frames, either horizontally or vertically, externally or internally, on both residential and commercial buildings.

This Design and Installation Guide recommends good building practice methodology and has been prepared as a general guide of design considerations,

system engineering information and installation procedures for common internal applications.

It assumes that the user has an intermediate knowledge level of building design and construction. In no way does it replace the services of the building professionals required to design projects, nor is it an exhaustive guide of all possible scenarios. It is the responsibility of the architect, designer and various engineering parties to ensure that the details in this Design and Installation Guide are appropriate for the intended application.

This guide refers to **internal installations** only, as components differ depending on the installation.

Refer to the 'Design and Installation Guide for Cemintel® Territory External Vertical Installation' or the 'Design and Installation Guide for Cemintel Territory External Horizontal Installation' for instructions regarding these applications.



PRODUCT OVERVIEW

Panel Information

Cemintel Territory cladding is a 16mm thick cement-bonded fibrous wood particle panel that's pressed with surface textures and finished with a high-quality paint and UV coating. The panels are 3030mm in length with an effective cover width of 455mm and connect seamlessly into each other via a tongue and groove profile.

The Territory cladding panels are supported by a proprietary concealed fixing system that enables the panels to be installed either horizontally or vertically, externally or internally, on both residential and commercial buildings.

Panels have a special NichiGuard® self cleaning coating* applied during the manufacturing process to Japanese standards. Panels include Platinum Coating technology to protect against UV damage and colour fade.

There is a range of coloured accessories including pre-formed external corner profiles, joint sealants and touch up paint kits to speed up installation and enhance the project finish and appearance.

An alternative aluminium corner can also be used for a more contemporary aesthetic.

Cemintel Territory cladding conforms to the requirements of BS EN 12467:2012 – Fibre-cement flat sheets - Product specification and test methods, Category A, Class 2. The BS EN 12467 bending strength testing demonstrates the Cemintel Territory cladding conforms to the requirements of AS/NZS 2908.2 – Cellulose-cement products, Part: 2 – Flat sheets, Category 3, Type A.

*Note: not all panels have NichiGuard self cleaning coating – check Technical Data Sheet.

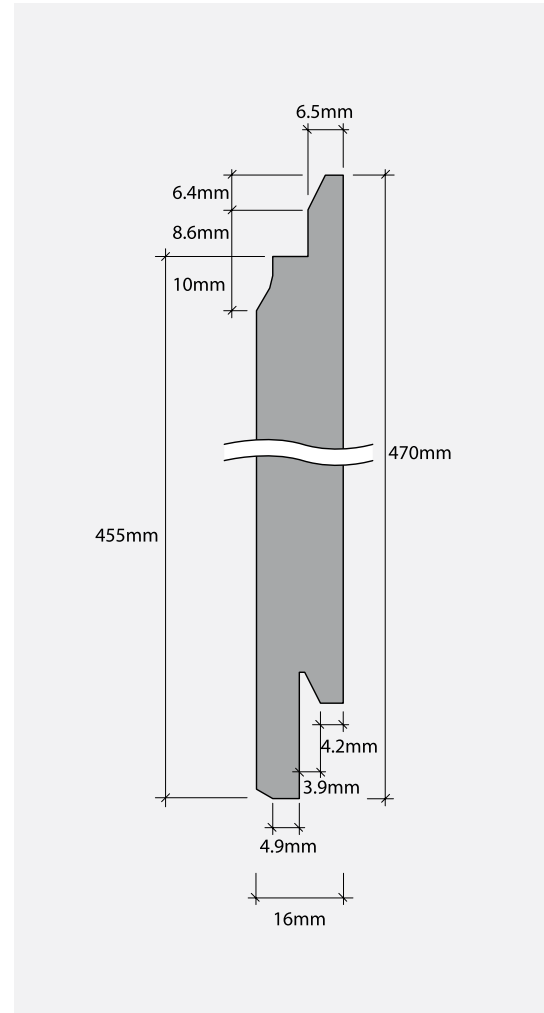

Product Specifications

Property	Specification	Tolerance	Reference
Panel Width	470mm (overall width) 455mm (effective coverage)	+1.0mm / -1.0mm	JIS A 5422
Panel Length	3030mm	+1.0mm / -1.0mm	JIS A 5422
Panel Thickness	16mm	+1.2mm / -1.2mm	JIS A 5422
Panel Weight (EMC)	24.6kg to 30kg per panel. Weight varies depending on finish. (Note: 2 panels per pack)		

PRODUCT OVERVIEW



Colour Palette

WOODLANDS

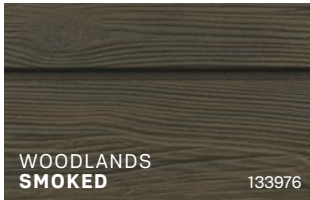

RIDGE

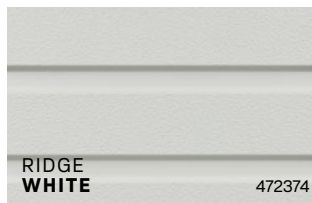
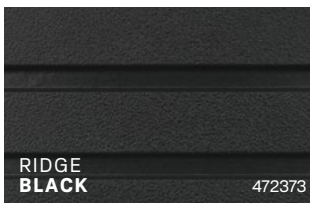

QUARRY

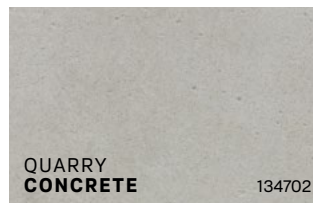

BRICK

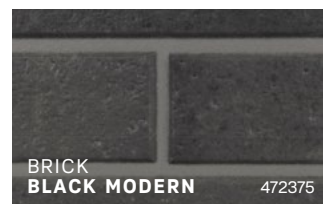

As Territory is a prefinished product, these images may vary from the actual product in regard to colour and surface finish. Panels should be inspected by the owner prior to installation to ensure they meet aesthetic requirements.

03

SYSTEM OVERVIEW

SYSTEM OVERVIEW



Cemintel Territory panels are installed with the unique Designer Series clip system.

Territory panels can be installed either horizontally or vertically. The clips, together with 5mm spacer strips and base starter strips create a largely concealed fixing system.

Metal corners can be used as an easy alternative to the pre-formed corners shown below.

Horizontal Installation

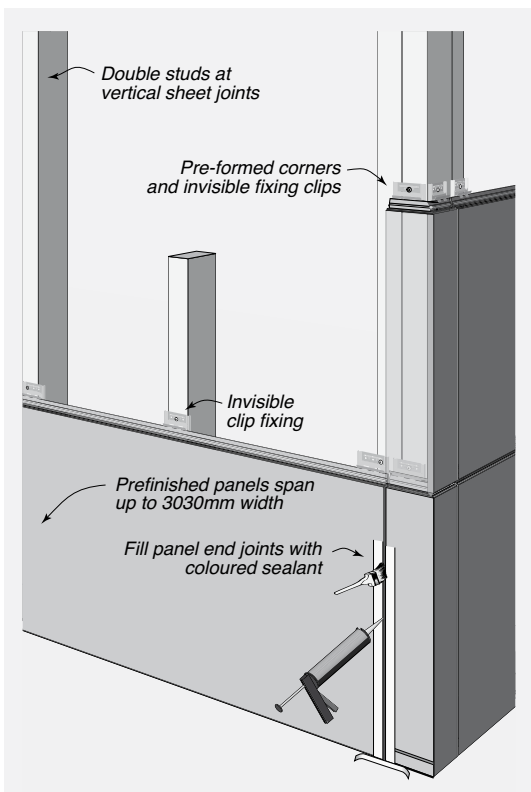

When installed **horizontally**:

- Panels span up to 3030mm width without joints.
- Studs can be at any spacings up to 600mm centres.
- Double studs or blocking are required behind vertical expressed joints to provide for fixing of the clips.

Vertical Installation

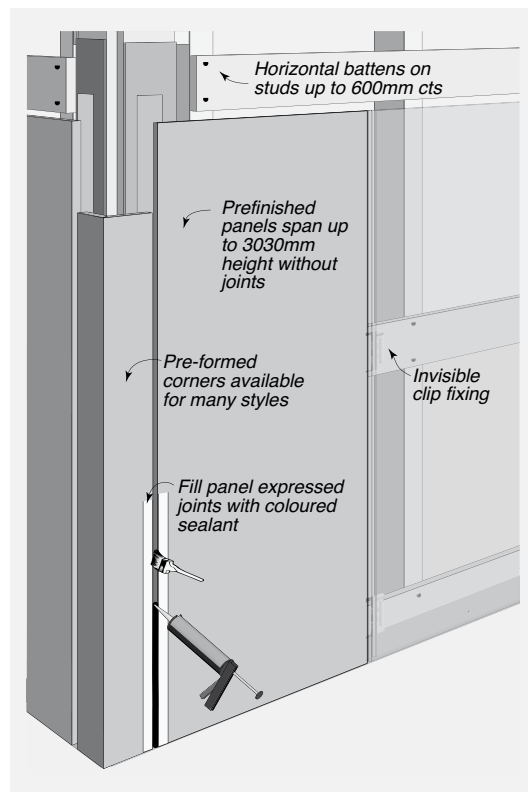

When installed **vertically**:

- Panels span up to 3030mm height without joints.
- Studs can be at any spacings up to 600mm centres.
- Horizontal battens are fixed to studs making this system particularly suitable for retro-fit to existing stud framing.
- Additional studs or blocking may be required at wall ends or at junctions with pre-formed corners to provide for fixing.

03

SYSTEM OVERVIEW



Applications

Cemintel Territory can be installed as an internal feature wall solution suitable for all building classes.



Benefits of the Cemintel Territory System

- CodeMark Certified CM30048.
- Fire – fibre cement sheets can be used where non-combustible material is required under the NCC provisions.
- Group Number 1 for internal lining in accordance with AS 5637.1/ISO 9705.
- Prefinished and available in a variety of colours and textures.
- Minimal ongoing maintenance and long lasting protection against UV damage and colour fade.
- Proprietary concealed fixing system provides a ventilated cavity for effective moisture management.
- Compatible with other Cemintel prefinished cladding systems including Surround and Barestone.
- Integrates easily into mixed façade systems that use concrete, brick, or AAC such as Hebel.
- Complete cladding system including preformed corners and coloured sealants.

A technical Data Sheet can be downloaded from cemintel.com.au

Product Specifications

Property	Specification	Tolerance	Reference
Panel Width	470mm (overall width) 455mm (effective coverage)	+1.0mm / -1.0mm	JIS A 5422
Panel Length	3030mm	+1.0mm / -1.0mm	JIS A 5422
Panel Thickness	16mm	+1.2mm / -1.2mm	JIS A 5422
Panel Weight (EMC)	24.6kg to 30kg per panel. Weight varies depending on finish. (Note: 2 panels per pack)		

A large, stylized number '04' is rendered in white with a thick outline, set against a dark blue background. The '0' is a simple oval shape, and the '4' is composed of three distinct strokes: a diagonal line, a horizontal line, and a vertical line.

DESIGN + AESTHETIC
CONSIDERATIONS

DESIGN + AESTHETIC CONSIDERATIONS

This section outlines some important areas for consideration in determining whether Cemintel Territory is suitable for the required application. The following points are not exhaustive. It is the responsibility of the Architect/Building Designer to ensure the design conforms to NCC requirements and other relevant building standards that may exist for the location. This guide should be read in conjunction with the NCC.

Face Fixings

Cemintel Territory is installed largely as a concealed fixing system. The panels are held in place by clips that are screwed to the frame. However, in some places, for example, around openings and corners where corner clips cannot be fixed, face fixed nails or screws may be used. A coloured touch up paint is available to cover the nails or screws in this instance.

Window & Door Openings

Cemintel Territory is compatible with industry standard aluminium and timber framed windows.

Where Territory panels are used to line the inside of external walls, consideration needs to be given to the total depth of the wall, taking into account the 16mm thickness of the panel and the 5mm cavity created by the fixing system.

Corners

The system offers the choice of either pre-formed matching corners or metal corners. In many cases the metal corners are considered easier to install.

Coverage

A Cemintel Territory panel has a nominal width coverage of 455mm.

Note that the recommended minimum cut panel size is 100mm in length and 200mm in height. Anything under this will most likely result in cracking. **All cut panels must have edges sealed to protect against moisture penetration.**

FIGURE 4.01 Panel Coverage Calculator
– Horizontal Installation

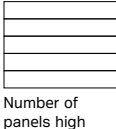

Territory Panel Rows (Height)	Coverage for Full Panels (mm nominal)
1	455
2	910
3	1365
4	1820
5	2275
6	2730
7	3185
8	3640
9	4095

FIGURE 4.02 Panel Coverage Calculator
– Vertical Installation



Territory Panel Rows (Width)	Coverage for Full Panels (mm nominal)
1	455
2	910
3	1365
4	1820
5	2275
6	2730
7	3185
8	3640
9	4095
10	4550
11	5005
12	5460
13	5915
14	6370
15	6825
16	7280
17	7735
18	8490
19	8645

Note: For vertical panels, the panels at external corners and wall junctions must be trimmed to form a square edge joint. This will reduce the coverage of the first and last panels in a wall.

DESIGN + AESTHETIC CONSIDERATIONS



Control Joints

Movement Control Joints

Control joints provided in the panel layout should be aligned with any movement control joints provided in the framing.

When undertaking building additions, a movement control joint must be installed at the junction of the existing framing and new framing. The cladding systems must be discontinuous at this joint.

When setting out panels, design consideration should be given to the location of joints to ensure that minimum panel lengths and heights are met.

Vertical Control Joints

Vertical sealant filled control joints are required at the end of each panel (at a maximum 3030mm spacings = full length panel), at junctions with pre-formed corners, and at other locations where the Territory wall adjoins another wall type to allow for differential movement (refer to 'Construction Drawings + Details' section). No additional vertical control joints are required.

Vertical joints in panels must be aligned and extend for the full height of continuous panelling, although additional joints may be placed over openings for ease of installation. As the joints are expressed and sealant filled, consideration to the positioning of joints is important for aesthetic reasons. Placing joints at sides or above openings, or the use of full height windows can reduce the visual impact of joints.

The quality of the sealed joints can impact the aesthetic finish, and care needs to be taken when applying the sealant. Refer to installation details for instructions on how to seal joints.

Structural

Framing and Substrate Options

Cemintel Territory can be fixed to timber or steel framing as well as to masonry substrates.

For timber and steel framing, the minimum requirement shall be in accordance with the following standards:

- AS 1684 – Residential Timber-Framed Construction.
- AS/NZS 4600 – Cold-Formed Steel Structures.

It is critical that the frame is true and plumb. Industry best practice for frame tolerance is 5mm misalignment over 3000mm.

Note: depending on the chosen panel layout, double studs may be required in some locations. Refer to 'System Engineering' section.

Structural Bracing

Cemintel Territory panels are indirectly attached to the structural framing via clips and spacers. As a consequence, they are not designed to provide wall bracing.

Bracing must be provided in the structural framing with methods such as sheet or strap bracing. Where sheet bracing is used, the entire wall framing to be clad with Territory panels must be sheeted to maintain a uniform fixing plane. Note: window setout will be affected.

Wind Loading Capacity

The Cemintel Territory panels with Panel Clips at a maximum 600mm spacing and installed in accordance with the construction details in this guide have a design ultimate wind pressure capacity of 0.50kPa for a minimum MGP10 timber framing and a minimum 0.50mm BMT G2 steel framing.



Other Design Considerations

Services

The Territory system will accommodate services that are run through the framing. Any notches or holes formed must be considered in the framing design.

Renovations

When undertaking building renovations, remove all lining from the original wall framing. Ensure the condition of the framing is in accordance with current requirements and is as true and as plumb as possible (within accepted industry tolerance of 5mm misalignment over 3000mm).

Install additional framing and insulation as required.

Limitations

Territory is not recommended and not warranted for the following applications:

- Wet areas such as bathrooms.
- Fireplace cladding.
- Exposure to temperatures greater than 50°C.
- Fixing of tiles or other materials to the face of the panel.
- The face is painted.

The above listing is not intended to be comprehensive. If in doubt, please contact Cemintel.

Inspection, Repair and Maintenance

Regularly inspect panel surfaces and follow wash-down procedures when required.

It is recommended storing additional panels in case any panels are damaged in the future. Any small chips can be painted over with touch up paint which both hides the underlying panel colour and seals the panel to prevent moisture ingress.

If a whole panel needs to be replaced, the panels which sit above it will need to be removed one by one from the heading, and then reassembled with joints resealed.

Wash Down Process

Panels have been coated with a factory finish which has 'self cleaning' properties.

Consequently, ongoing maintenance should be limited to an occasional wipe down with a damp cloth or using a soft brush (like a dust pan brush).

When diluting the neutral detergent, follow the manufacturer's instructions and use the weakest solution possible.

05

COMPONENTS + ACCESSORIES

05

COMPONENTS + ACCESSORIES

Note: Codes can change from time to time. Refer to the website for the current list of components prior to ordering.







Cemintel Territory Panels and Accessories

Product Name	Panel (2 Pk)	Touch-Up Paint	Soudal Primer 150 Porous Surfaces Clear 500ml	Territory Coloured Joint Sealant Soudal Multibond SMX® 25 Sausages 600ml	Pre-formed External Corner Horizontal#	Pre-formed External Corner Vertical#
WOODLANDS Smoked	133976	165354	492501	Charcoal 492500	134409	134415
WOODLANDS Teak	133975	165355	492501	Redwood 492487	140727	140713
WOODLANDS Grey Gum	472376	478226	492501	Concrete Grey 492484	472325	472344
WOODLANDS Ebony	163108	165356	492501	Charcoal 492500	163109	163110
WOODLANDS Birch	472366	478227	492501	Sandstone 492488	472327	472346
WOODLANDS Lined	163175	165358	492501	Beige 492482	163225	163247
WOODLANDS Kwilla Slats	472361	478229	492501	Charcoal 492500	472329	472348
QUARRY Urban Grey	133977	165372	492501	Concrete Grey 492484	134410	134416
QUARRY Concrete	134702	165372	492501	Concrete Grey 492484	134410	134416
RIDGE Black	472373	478301	492501	Black 492483	472336	472351
RIDGE WHITE	472374	478302	492501	White 492489	472337	472352
BRICK Red Rustic	472367	488750	492501	Dark Grey 492485	484734	Note Available
BRICK White Rustic	472359	488753	492501	Off White 492486	484738	Note Available
BRICK Grey Rustic	491940	488751	492501	Beige 492482	491944	Note Available
BRICK Black Modern	472375	488752	492501	Dark Grey 492485	484737	Note Available

Pre-formed External Corners are manufactured to match panels. Internal measurement – 70mm x 70mm. Coverage nominal 86mm x 86mm x 455mm (Horizontal), 86mm x 86mm x 3030mm (Vertical).

Other Accessories/Tools

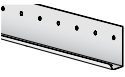

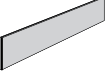

Note: To guarantee performance, only approved fasteners should be used in these systems. Where nominal fasteners are required, Class 3 minimum finish products must be used.

Accessories	Description	Use*	Size/Colour	Quantity	Product Code
	Screws for Timber Framing – used to fix starter strip, clips and other components. Stainless steel 410 grade and clear coated.	ALL	35mm	500 per pack	105366
	Nails for Timber Framing – for fixing panels at soffit line and other locations where required. Ribbed shank, flat head, stainless steel 304 grade. Pre-drill panels for all nails.	ALL	75mm	230 per pack	105298
	Screws for Steel Framing – for face fixing panels at soffit line and other locations where required. Class 3, self-drilling, CSK self-embedding head, Phillips drive. Suitable for minimum 0.75mm BMT steel framing.	ALL	10g x 55mm	500 per pack	113603
	Screws for Steel Framing – for fixing starter strip, clips and other components. Class 3, 8g, self-drilling, button head, Phillips drive.	H	20mm	1000 per pack	113604
	Internal Horizontal Starter Strip – steel profile used at the base to locate the first row of panels. Provides 5mm offset from face of studs. Manufactured from 1.2 BMT steel with galvalume AZ150 corrosion resistant coating.	H	3030mm	1 each	136824
	5mm Panel Clip – fixed to the framing to retain the tongue and groove edges of panels. SGMC400-K27 corrosion-resistant coated steel in accordance with JIS G 3323.	ALL	60mm x 45mm x 5mm	50 per pack	114913
	5 x 50mm Horizontal Spacer – for packing between framing and panels at eaves and soffit trim. Manufactured in extruded plastic.	ALL	5mm x 50mm x 1200mm	1 each	129266 (green) 493475 (grey)

COMPONENTS + ACCESSORIES

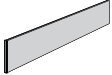
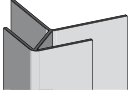





05

Note: Codes can change from time to time. Refer to the website for the current list of components prior to ordering.



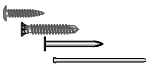

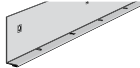
Accessories	Description	Use*	Size/Colour	Quantity	Product Code
	5 x 45 x 45mm Self Adhesive Spacer – for use where small segments of spacer are required.	ALL	5 x 45 x 45mm segments 1000mm	1 each	114912
	External Metal Corner Trim – anodised aluminium extrusion used to dress and finish external corners. 60mm x 65mm x 3030mm	ALL	Charcoal	1 each	126961
Pearl				135040	
Silver				135041	
	Backing Rod – used to enable correct filling of some joints with sealant. The diameter of the backing rod must be appropriate for the width of the gap being filled.		10mm dia. x 50m roll	1 each	11177
	Sealant Bond Breaker Tape – used to enable correct filling of some joints with sealant. Tesa Multiform Tape No. 7492, polyethylene closed cell foam tape. Self adhesive back.		48mm x 3mm x 25m	1 each	13172
	Cemintel Edge Sealer – for sealing panel edges after on-site cutting.		200ml 2ltr	1 each 1 each	100166 180928

* H refers to components for horizontal installation. V refers to components for vertical installation. ALL refers to components for both horizontal and vertical installation.

For Vertical Installations, the following additional components are required:

	Nails for Fixing Battens – machine driven D-head nails, galvanised.	V	2.8 x 50mm	3000 per pack	127799
	Screws for Fixing to Timber Battens – button head screw used for fixing starter strip, panel clips and other components to battens. Class 3 finish.	V	#8 – 20mm x 15-18 TPI	Supplied by others	
	Fasteners – to fix backing strip and other components to framing. - For fixing to timber framing – galvanised clout, 40 x 1.6mm - For fixing starter strip, panel clips and other components to timber battens. Button head screw used for fixing Class 3 finish. - For fixing to steel framing – button head screws, Class 3, 6g x 40mm self-drilling, Phillips drive	V	Supplied by others		
	Timber Batten – battens are fixed to structural studs to accept fixing clips	V	18-20mm x 90mm	Supplied by others	
	Internal Vertical Starter Strip – steel profile used at the base to support the first row of panels. Manufactured from 1.0mm BMT steel with galvalume AZ150 corrosion resistant coating	V	3030mm	1 each	471902
	5 x 90mm Vertical Spacer – for packing between battens and panels at corners and other locations where face fixing is required. Manufactured in extruded plastic.	V	5mm x 90mm x 2000mm	1 each	128996 (green) 493476 (grey)

Tools

Product	Description	Size	Quantity	Product Code
	Makita Plunge Saw Kit (1300W) includes 1400mm guide rail and bonus 165mm fibre cement saw blade – excellent for cutting cement based sheets	165mm	1	165485
	Makita 165mm Fibre Cement Saw Blade – ideal for use with the Makita Plunge saw and other 165mm circular saws fitted with vacuum extraction systems	165mm x 20 x 4T	1	165486
	FESTOOL TS 55 EBQ Plunge Cut Saw – with 1400mm Guide Rail. Precise plunge cuts in materials up to 55mm thick.	160mm	1	121400
	FESTOOL Diamond Tipped Blade for TS 55 – for cutting all fibre cement sheet products	160mm	1	112647
	Cemintel Power Saw Blade – specifically designed for cutting pre-finished cement based sheets. Ideal for use with dustless circular saws fitted with vacuum extraction systems. 15000 RPM max.	125mm	1	134449

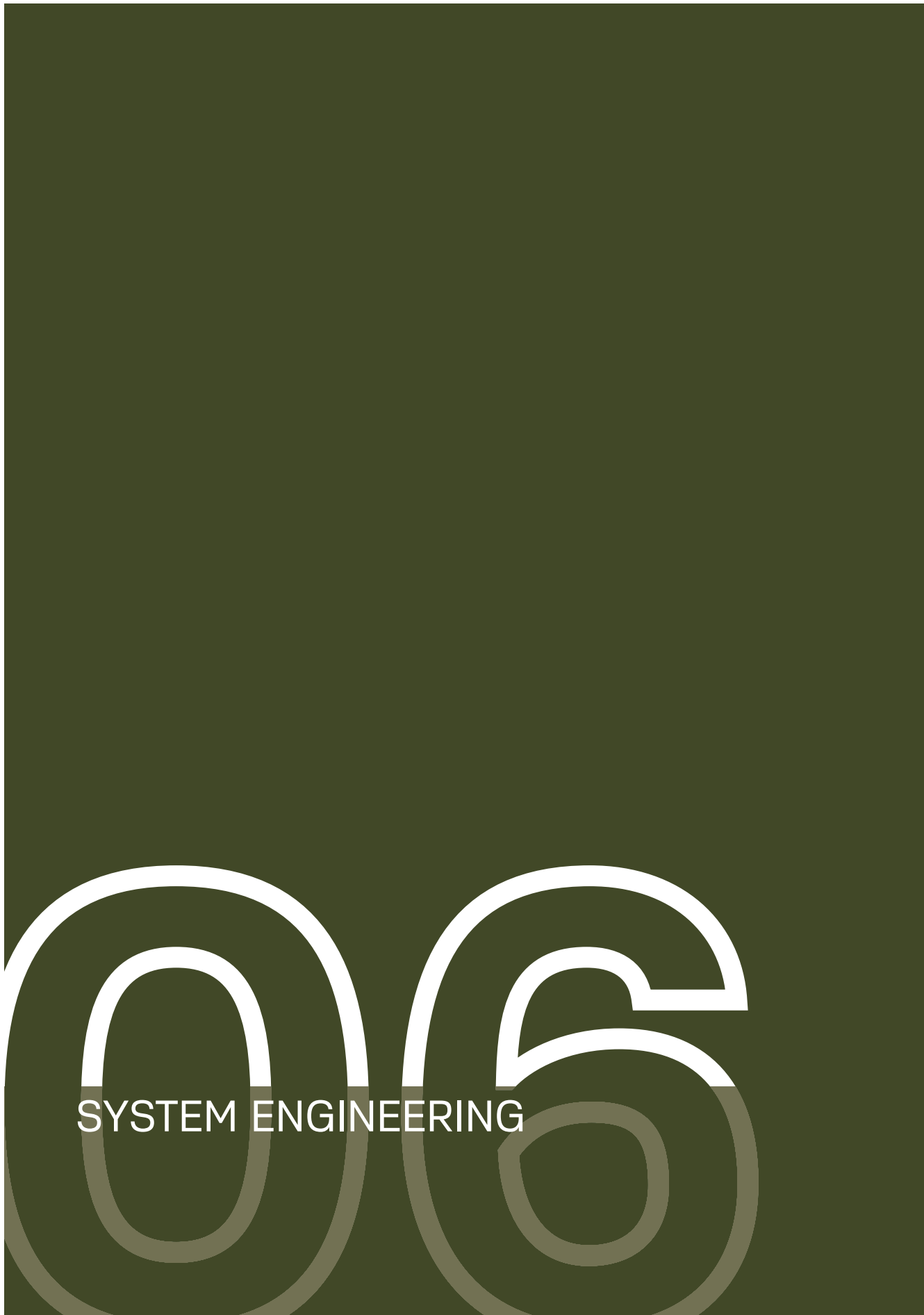

SYSTEM ENGINEERING

SYSTEM ENGINEERING



Design, Detailing And Performance Responsibilities

Cemintel engages independent testing laboratories to test and report on the performance of a wall in accordance with the relevant Australian Standards. Consultants with relevant experience will use these test reports to provide opinions and assessments that extend the tested arrangement to include various on-site installation configurations and details that meet appropriate criteria performance.

Project Consultants (Structural, Fire, Acoustic, Etc.)

These consultants are typically responsible for the following:

- Opinions on expected laboratory performance of wall configurations that vary from actual test configuration, such as substitution products and components.
- Judgements about expected field performance using laboratory test reports and practical experience.
- Design, specification and certification of structural, fire, acoustic, durability, weather tightness and any other required performance criteria for individual projects.

This involves the design and selection of building elements, such as wall and floors and their integration into the building considering the following:

- Interface of different building elements and to the structure / substrate.
- Wall and floor junctions.
- Penetrations.
- Flashing issues.
- Room / building geometry.
- Acoustic and water penetration field-testing.

Design Responsibility

Panels, top hats and structural framing are required to resist wind loads that are specific to the building site. Additional 'local pressure factors' can apply to the panels and top hats in accordance with the wind code AS/NZS 1170.2. It is recommended that the Architect/Building Designer assigns the responsibility for the facade design to the Project Engineer. Once wind loads have been determined, top hat spans, fastener spacings, and sheet fixing details may be selected from the appropriate tables in this manual. It is also the responsibility of the Architect/Building Designer to select the appropriate corrosivity category. Refer to appropriate details in this guide.

The performance levels of walls documented in this guide are either what is reported in a test or the documented opinion of consultants. Performance in projects is typically the responsibility of:

Project Certifier and/or Builder

These professionals are typically responsible for:

- Identifying the performance requirements for the project in accordance with the NCC and clearly communicating this to the relevant parties.
- Applicability of any performance characteristics supplied by Cemintel including test and opinions for the project.
- The project consultants' responsibilities detailed above if one is not engaged in the project.

Cemintel does not provide consulting services. Cemintel only provides information that has been prepared by others and therefore shall not be considered experts in the field.

Any party using the information contained in this guide or supplied by Cemintel in the course of a project must satisfy themselves that it is true, current and appropriate for the application, consequently accepting responsibility for its use.

It is the responsibility of the Architect/Building Designer and engineering parties to ensure that the details in this design guide are appropriate for the intended application.

The recommendations in this guide are formulated along the lines of good building practice, but are not intended to be an exhaustive statement of all relevant data.

Cemintel is not responsible for the performance of constructed walls, including field performance, and does not interpret or make judgements about performance requirements in the NCC in a specific project application.

Note: it is the responsibility of the Project Engineer to specify the connection of the top hats to the support structure. It is also the responsibility of the Project Engineer to calculate the wind loads for the cladding of a project.

07

INSTALLATION

INSTALLATION

07

CHECKLIST – Prior to Installation

The following pre-install checklist may assist to ensure you have the best possible outcome when using Cemintel Territory.

- Ensure substrate is straight and plumb. Pack studs to straighten if necessary (timber frames as per AS 1684, steel frames as per AS/NZS 4600. Industry best practice for frame tolerance is 5mm misalignment over 3000mm.
- Ensure studs are correctly located and of the appropriate thickness.
- Confirm bracing is in place. Where sheet bracing is used behind panels, the entire wall area needs to be braced or bracing sheet packers fixed to the frame to ensure a uniform fixing plane.
- Confirm your panel layout to determine the location of joints and identify where additional studs are required at all short edge joints and internal and external corners.
 - If using pre-formed corners, studs need to be located to allow fastening of corner clips to support the corners.
 - Additional studs or blocking may be required for support and fixing of Territory joint backing strips at corners and junctions.
- Confirm appropriate window detailing to accommodate Territory panel set out (taking into account the 16mm panel thickness and 5mm cavity created by the clips, spacers etc).
- Where there is no space to use a mounting clip along the bottom and top edge of the window, tack a horizontal spacer to provide a firm surface for the cladding panel to maintain its position.
- Confirm the detailing for the base, head and end of wall junctions.
- Confirm services and insulation have been installed in framing where appropriate.
- Confirm adequate structural support for fixtures such as shelving, signage etc.



Check quality and quantity of panels and components before installing. If there is any sign of damage or visible defects in panels, or the colour/finish is not in keeping with the owners aesthetic requirements **DO NOT INSTALL**. Contact Cemintel to address any issues.



**Horizontal Installations – Clips on Stud Fixing
Installation Set-Out**

Timber and Steel Framing

All framing must be in accordance with the following AS 1684 – Residential Timber-Framed Construction and AS/NZS 4600 – Cold-Formed Steel Structures.

Studs are to be installed at 600mm maximum centres. Double studs are required at all panel end joints.

FIGURE 7.01 Typical Framing Set-Out with 70mm Timber or Steel Framing and Pre-formed Corner – Plan View

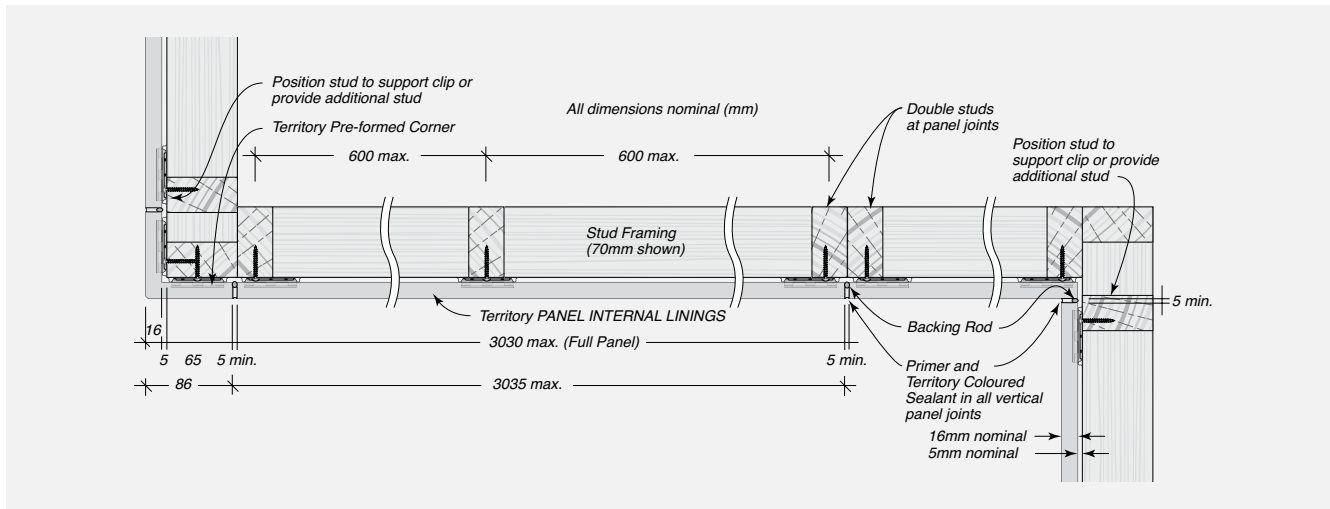
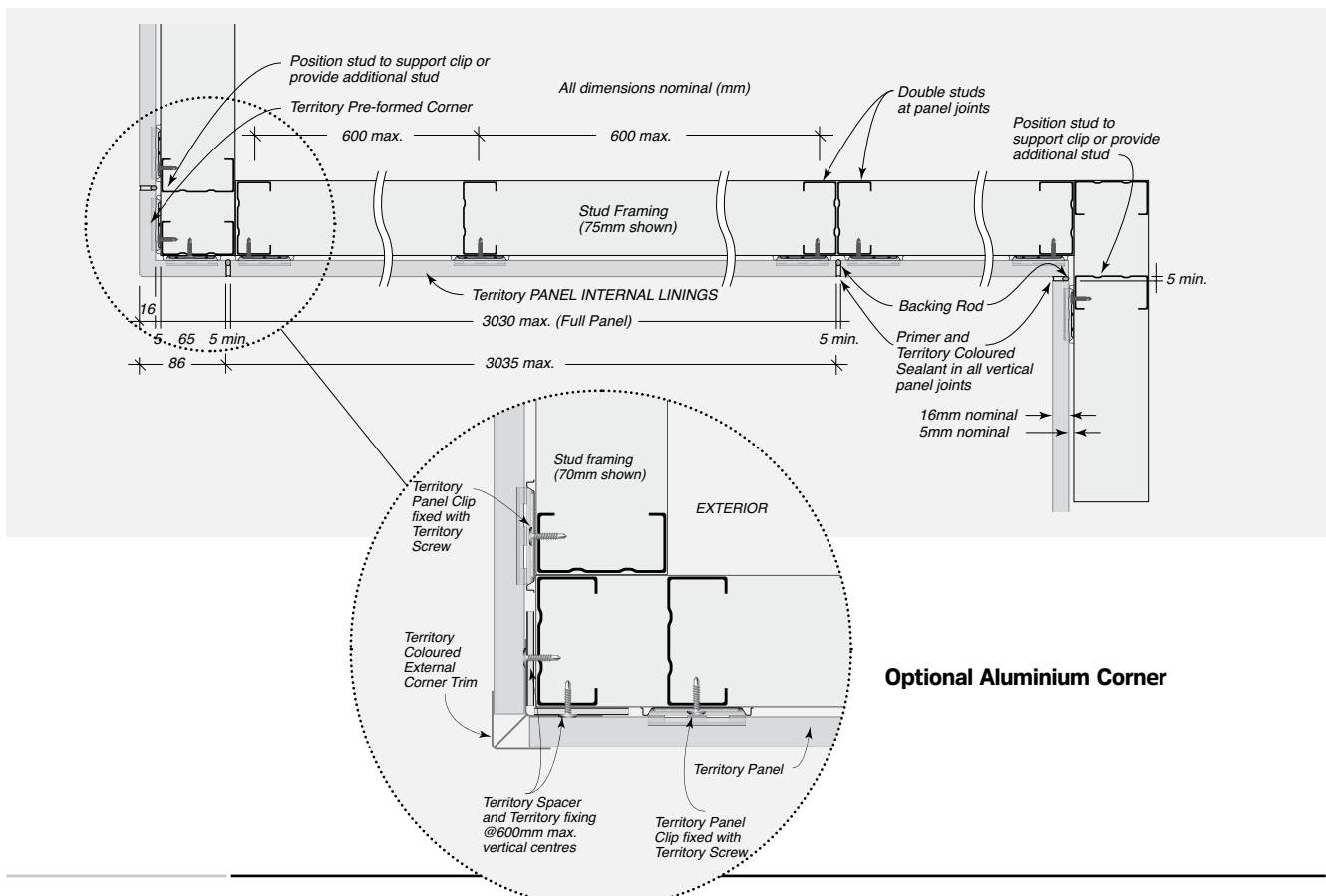

FIGURE 7.02 Typical Framing Set-Out with 75mm Steel Framing and Pre-formed Corner – Plan View



Steel Framing

FIGURE 7.03 Typical Framing Set-Out with 90mm Timber or Steel Framing and Pre-formed Corner – Plan View

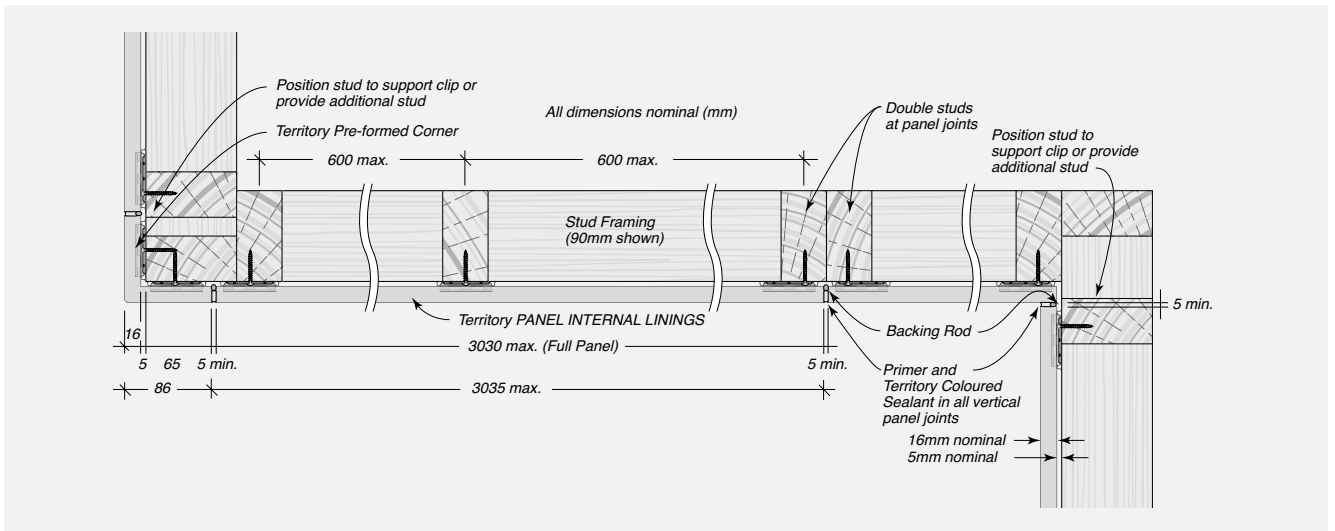
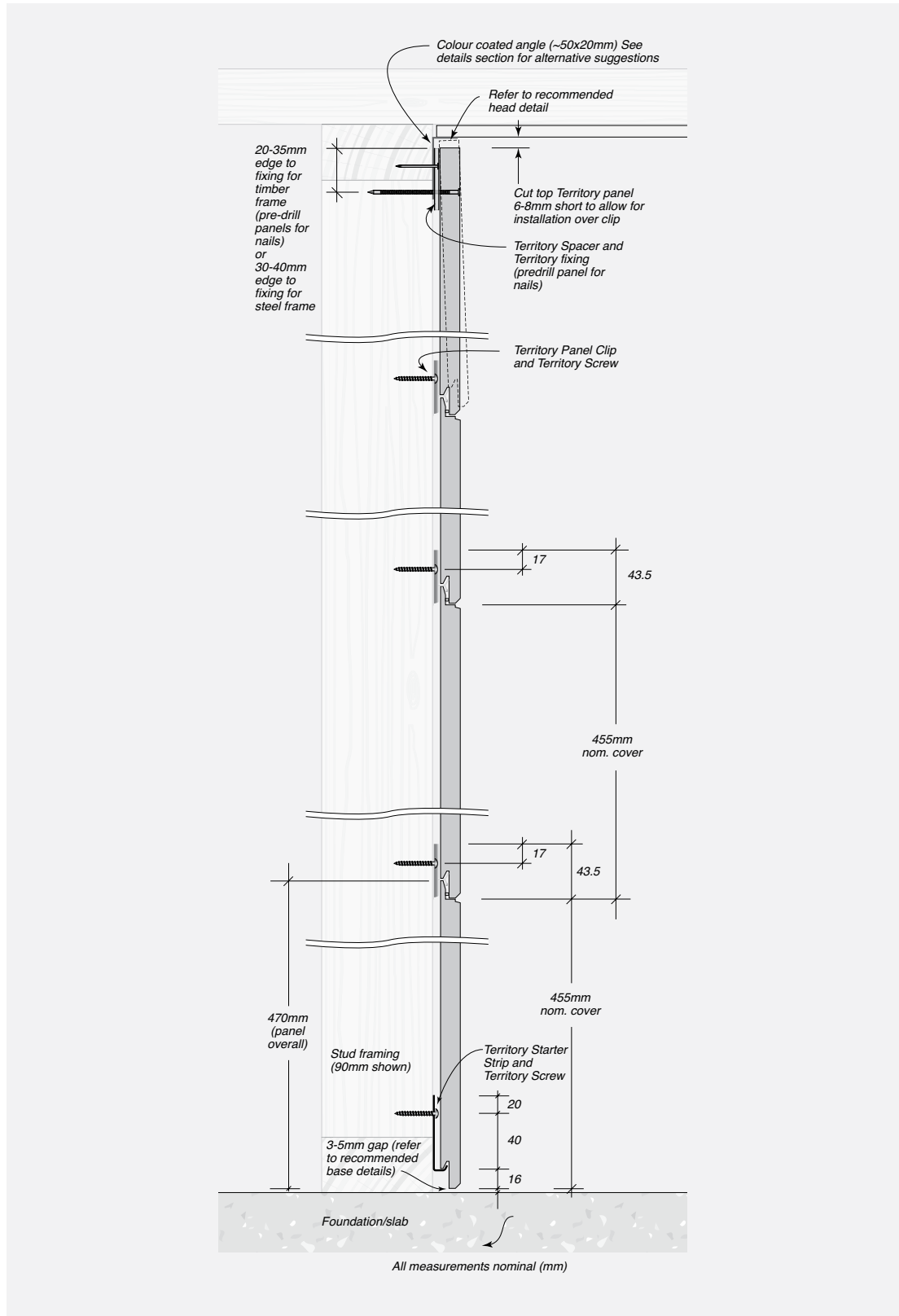

FIGURE 7.04 Typical System Cross Section - Elevation



Horizontal Installation

Step 1 – Install horizontal starter strip to the base of the wall. Measure to allow for the 16mm overhang of the panel when it sits on the starter strip. Screw the starter strip level along the whole length of the strip to the base plate/studs. Because each panel sits on top of the other, any errors in setting the level on the first wall panel will be compounded through each layer. It is therefore critical to ensure the starter strip is fitted level, ready to accept the first panel.

Step 2 – Install Corners (note if no external corner exists start installing panels at one end of the wall).

- A.** If installing pre-formed corners, slide the first corner piece down the corner and over the starter strip. Then insert a panel clip on each side and screw to the stud. It is important to ensure that each corner piece is square on both sides. If the corners are not square, pack out the clips. To add the next corner piece, slide it on top so that it sits firmly on the clips and tap into position. Secure another set of clips to the top of the panel and screw fix to framing.
- B.** If installing aluminium corners, cut to length. Notch out to extend over the starter strip. To maintain the 5mm cavity, first tack vertical spacers on each side of the corner stud. Then, ensuring the metal corner is correctly positioned, nail or screw it through the spacer to the frame. The wall panel should fit into the corner trim channel and slide down onto the starter strip.

Step 3 – Install wall panels. Place the first wall panel over the starter strip and slide into place. Position panel clips at every stud and screw into place. Pack out the clips if necessary to ensure a uniform fixing plane. Continue to install the first row of panels horizontally onto the starter strip. Use tile spacers or similar to form a 5mm gap at all panel end vertical joints. Ensure vertical joints are accurately aligned. Continue to secure clips to the top (tongue) of the panel, tap firmly into place and screw fix to framing.

Where face fixing may be required, a strip of horizontal spacer (or cut to a minimum length of 200mm) should be positioned between the panel and the frame thus maintaining the 5mm cavity.

Step 4 – Finishing at the wall head. Determine appropriate head detail. If installing a metal angle, install prior to fixing panel. At the wall head face fixing is required. Install horizontal spacer strip behind all panel fixing points to maintain the 5mm cavity. Cut the top panel/pre-formed corner 6-8mm shorter than the height of the wall to allow lifting of the final panel and dropping into place. Mark the position of the studs to identify fastening points. Predrill fastener holes. Fasteners should be located 20-35mm from panel edges for timber frames or 30-40mm for steel frames.

Tilt the panel out at the bottom, lift panel up and locate the bottom edge of the panel onto the clips already installed. Once firmly in place, fasten panels to the studs using the Cemintel supplied face fix fasteners.

Step 5 – Caulk all expansion joints (ref Fig. 7.05). Ensure the Territory panels are dry before applying primer and Territory Coloured Joint Sealant. Remove dust, grease, moisture and clean the joint to be caulked. Install backing rod into the vertical joints.

Apply masking tape to each side of the vertical joints and at the base, ensure the tape follows the caulk edge and surface profile. Paint the edges of the panels with the primer and immediately remove excess primer from the tape or main face of panel. The primer helps the sealant adhere to the panels. Wait a minimum 1 hour and maximum 4 hours before applying the sealant. Provide another primer coat for wait times greater than 4 hours.

Fully fill joint with sealant. Smooth off the finish with manufacturer recommended products, removing excess sealant.

Care must be taken when removing the masking tape to ensure no damage to the surface or edge of the caulked joint. Note: CARE NEEDS TO BE TAKEN NOT TO GET SEALANT AND/OR PRIMER ON THE MAIN FACE OF PANELS as this can result in marks and stains on the panel face.

Install sealant to gaps at windows and other penetrations.

Step 6 – Touch up any exposed fasteners. Wipe panels down with a damp cloth and touch up any exposed nail or screw heads with matching touch up paint.

FIGURE 7.05 Typical Method for Sealing Vertical Joints

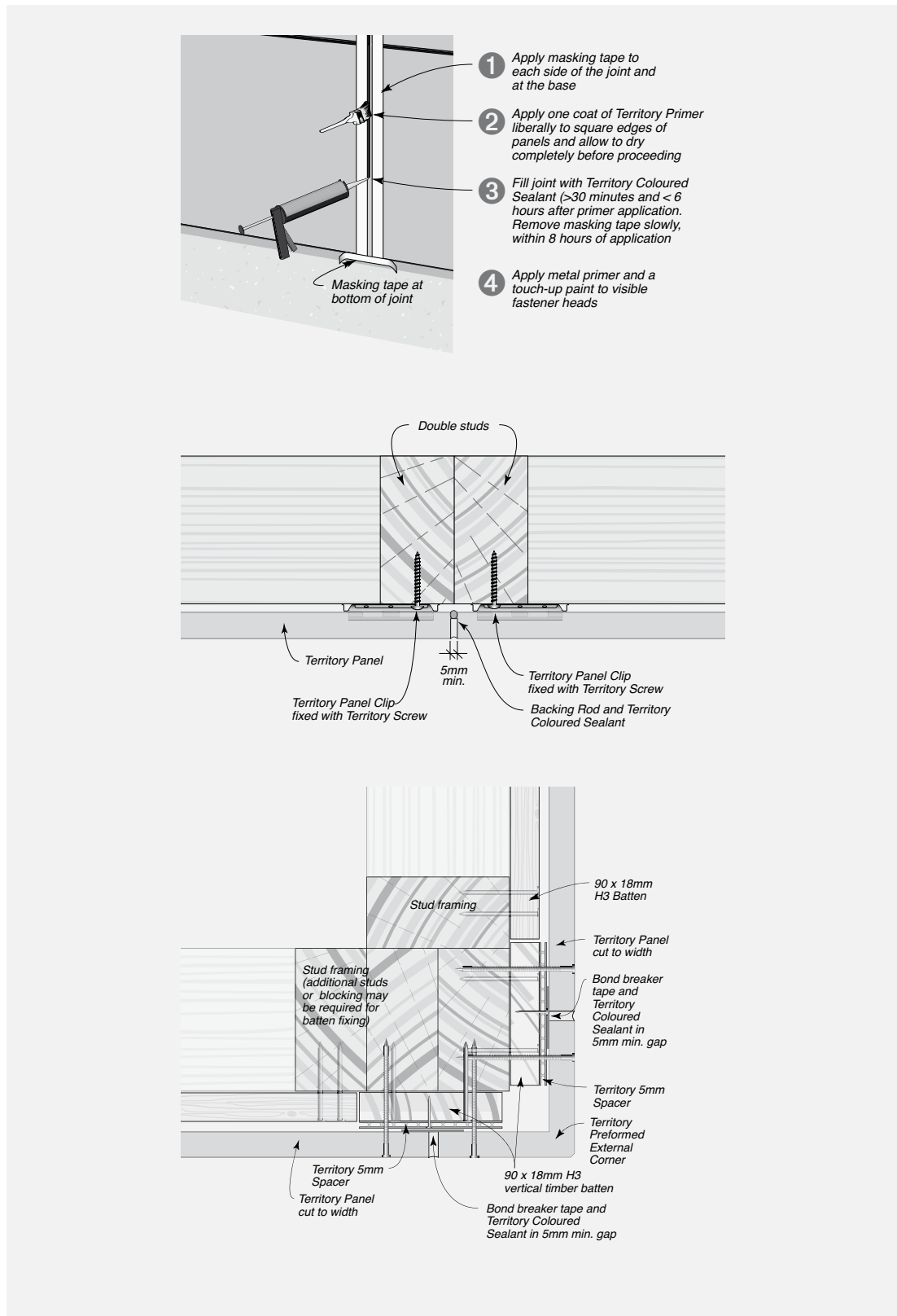

INSTALLATION



- 1 Stud (double for vertical joints)
- 2 Horizontal Starter Strip
- 3 Pre-formed horizontal corner
- 4 Panel
- 5 Panel clip
- 6 Backing rod
- 7 Primer and sealant
- 8 Horizontal Spacer strip

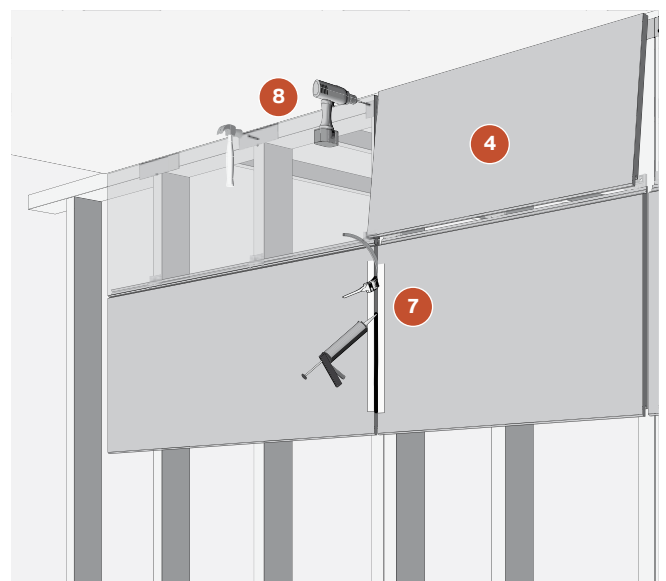
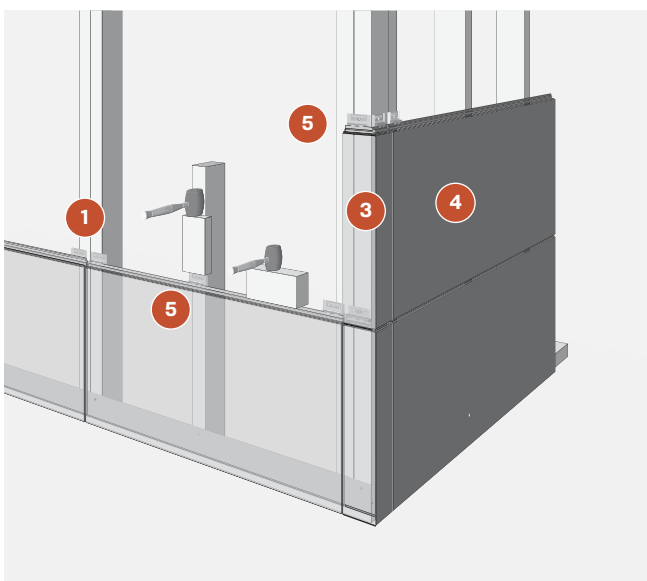
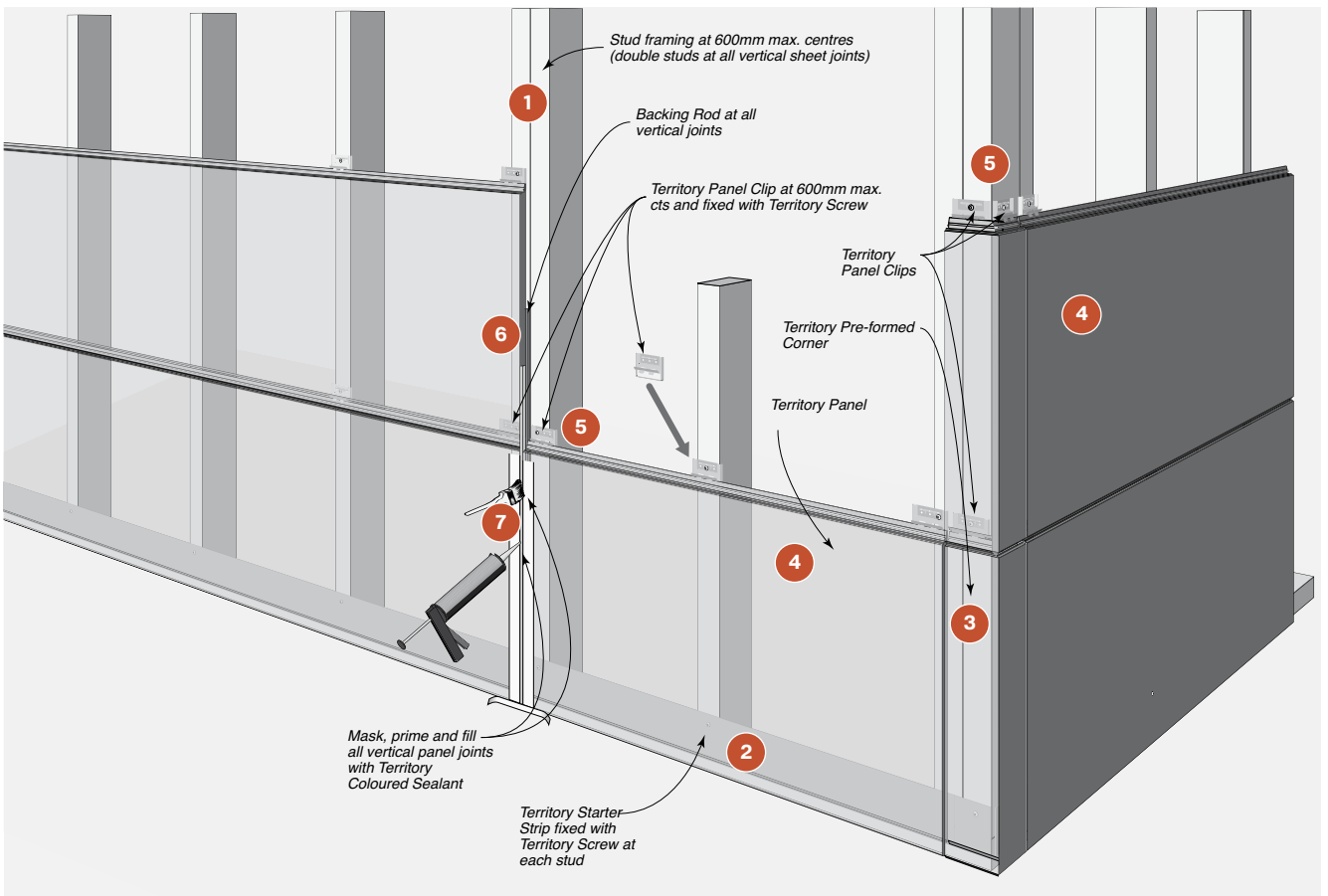

Vertical Installation – Clips on Batten Fixing Installation Set-Out

Timber and Steel Framing

All framing must be in accordance with the following AS 1684 – Residential Timber-Framed Construction.

The Territory Vertical Panel on-batten system is detailed here with 90mm x 18mm timber battens. Battens must be spaced at 600mm maximum centres, and fixed with two nails or one screw to each stud.

Battens may be aligned or offset.

Aligned battens may require additional blocking or studs to allow landing and fixing of batten ends (ref Fig 7.06).

FIGURE 7.06

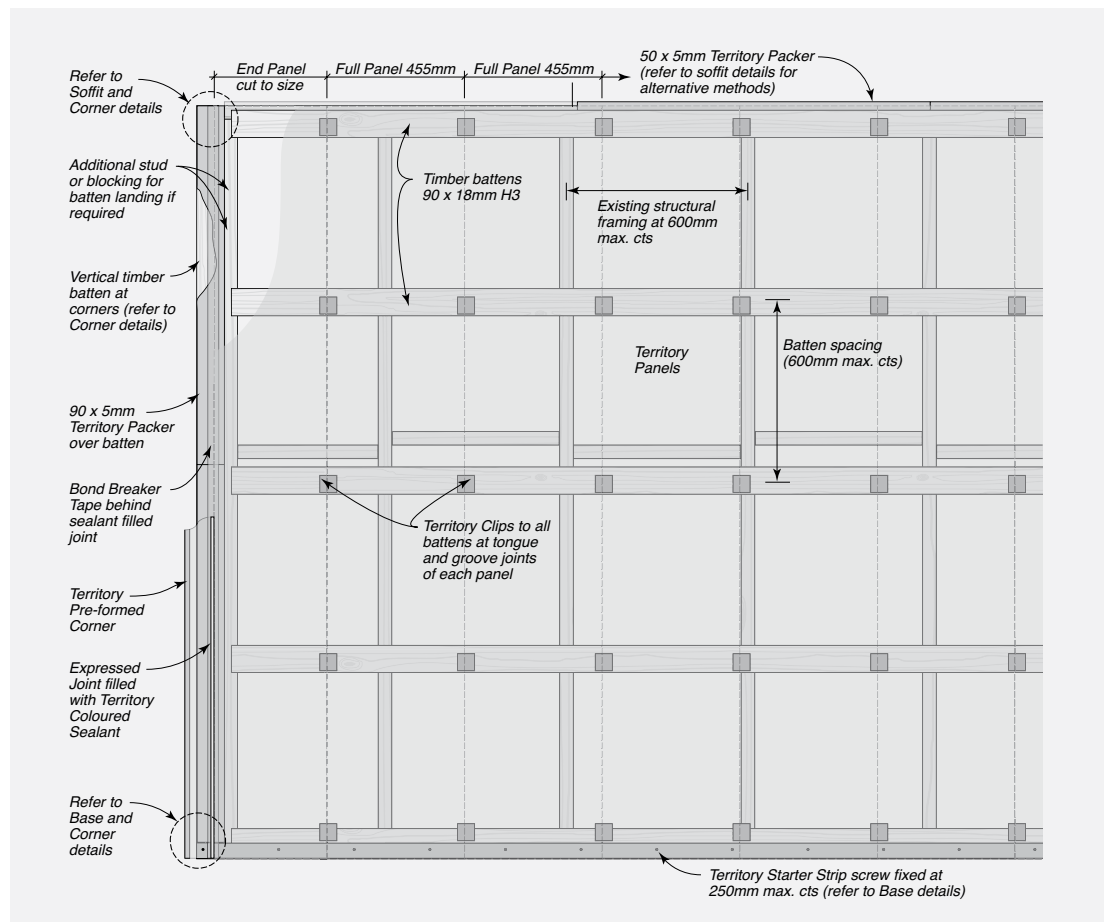

Panel Layout and Fixing

Vertical panel installation requires a square edge to the panel at junctions with a Territory pre-formed Corner or Metal Corner Trim, at internal corners and at junctions with masonry or other wall systems. This requires removal of the tongue or groove from one edge of the end panels. These panels can be trimmed to between 200mm and 430mm nominal cover. These panel widths should be considered when panel joint location is important for aesthetics (ref Fig 7.07 and 7.08).

All face fixings must be backed and supported by the Territory vertical spacer.

Panels must be fixed to the structural framing along trimmed edges with 75mm nails at 20-35mm from the panel edge for timber framing (or with Territory 55mm screws at 30-40mm from the panel edge for steel framing) and at spacings aligned with adjacent battens (ref Fig 7.12).

All other panel joints require the factory finished tongue and groove for fixing with panel clips. Clips are to be fixed to battens with 20mm button head screws. One screw may be used in the clips at the wall head and base. Two screws must be used in all other panel clips.

FIGURE 7.07 Non-symmetrical Panel Set-Out

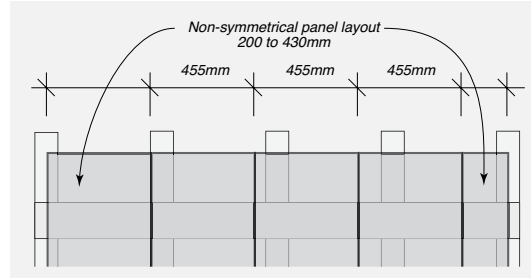

FIGURE 7.08 Symmetrical Panel Set-Out

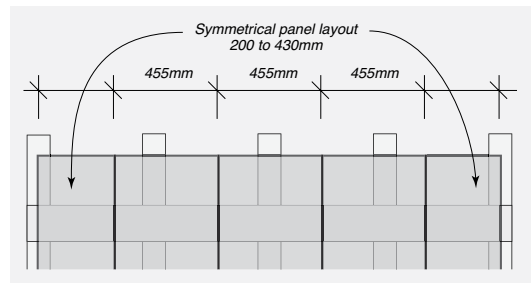
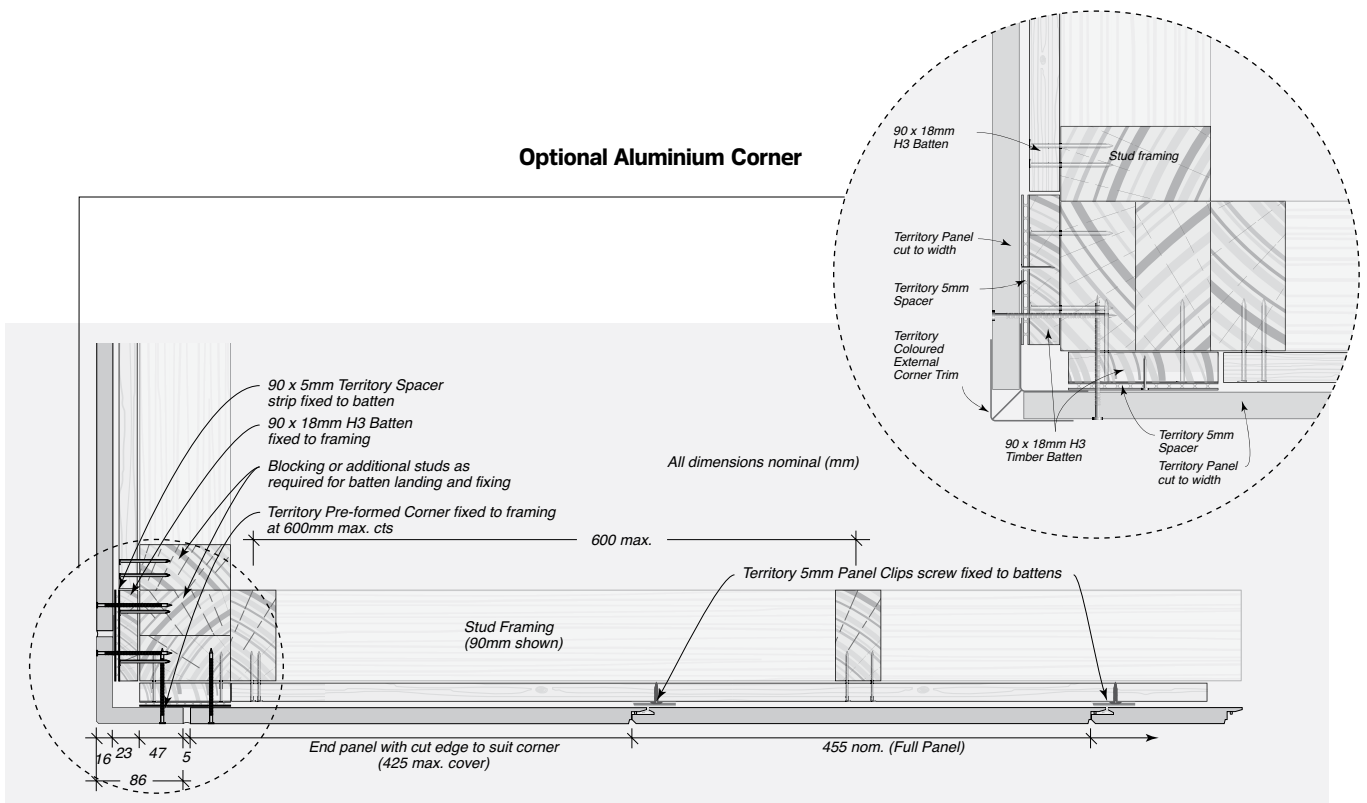

FIGURE 7.09 Typical Framing Set-Out with 90mm Timber or Steel Framing and Pre-formed Corner – Plan View



07

INSTALLATION

FIGURE 7.10 Typical Framing Set-Out with 70mm Timber Framing and Territory Pre-formed Corners - Plan View

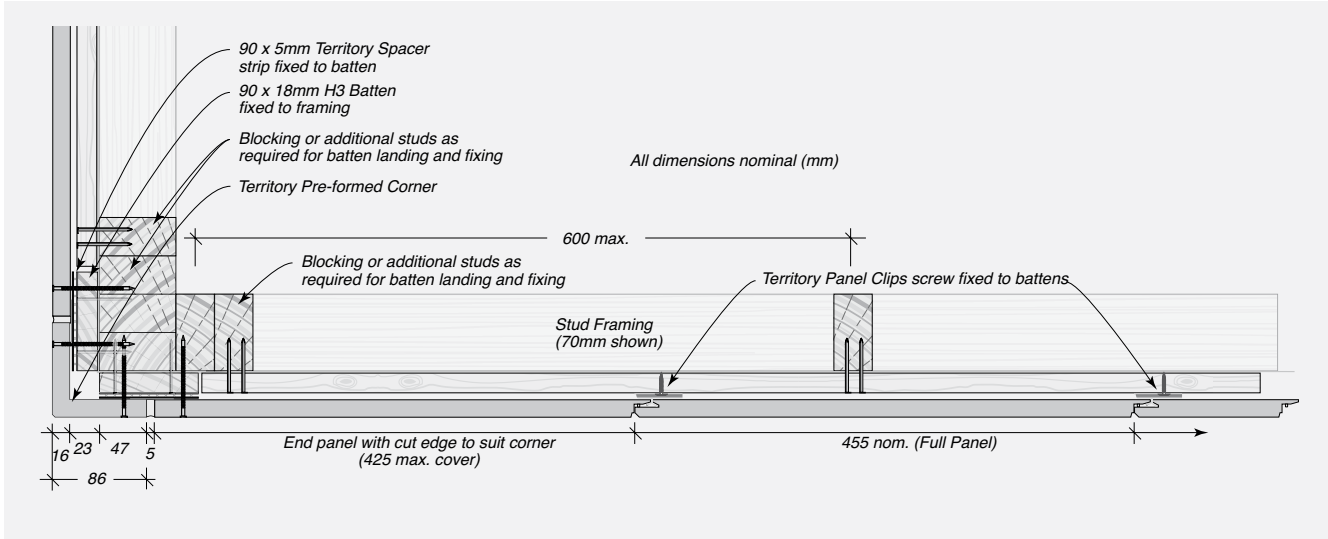

INSTALLATION



FIGURE 7.11 Typical Territory System Cross Section – Elevation

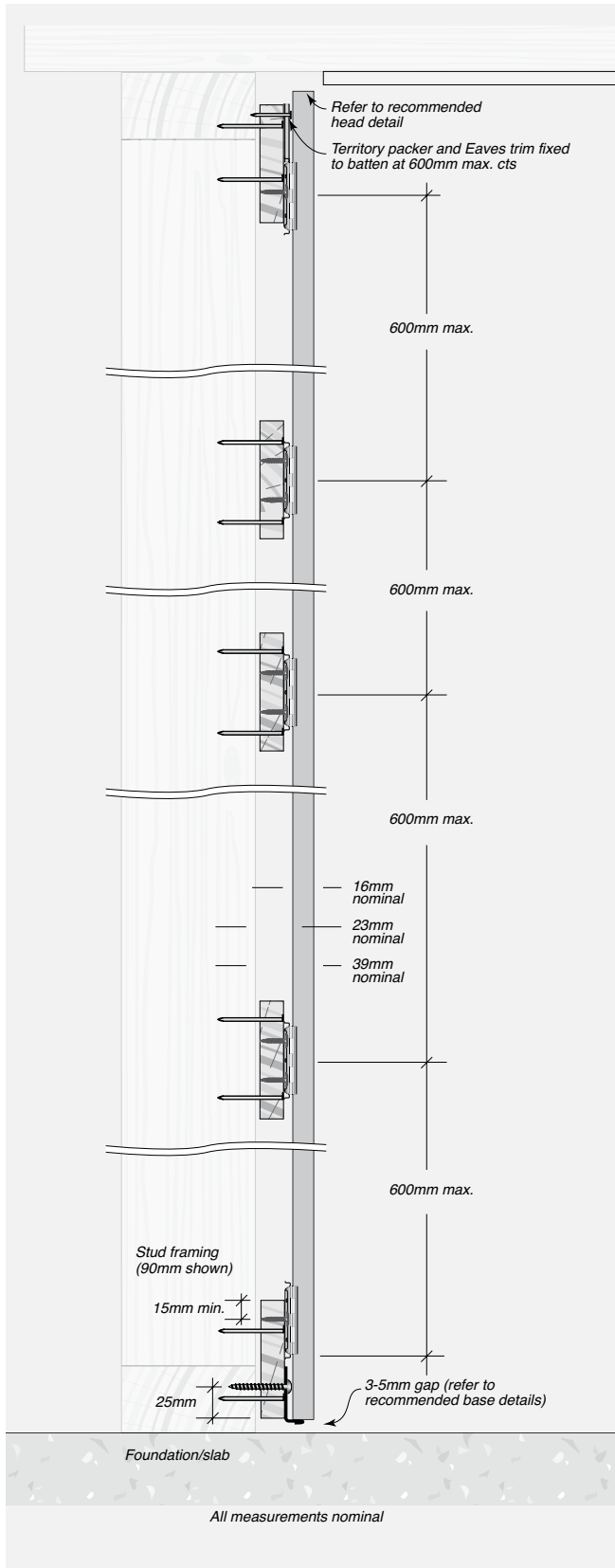
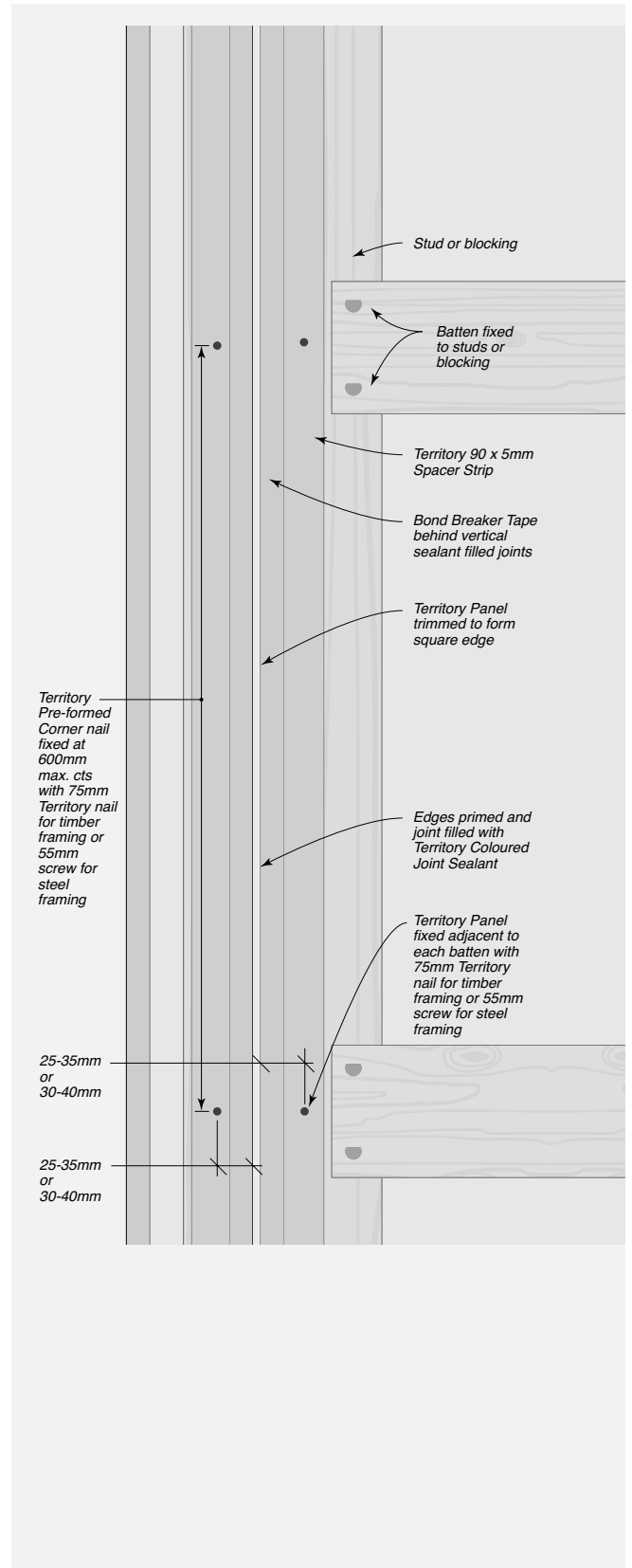

FIGURE 7.12 Typical Face Nailing at Square Edge Joint – Elevation



Vertical Installation

Step 1 – Install Battens. Install horizontal battens to studs with 2 nails or 1 screw (additional blocking/studs may be required). Install vertical battens to studs with 2 nails or 1 screw at all corners and where Territory panels abut other wall types.

Step 2 – Install vertical starter strip to the base of the wall. Ensure there will be a minimum 3-5mm clearance between the floor surface and bottom of the panels. Fasten the starter strip level along the whole length of the strip to the bottom plate at 250mm maximum centres.

Step 3 – Prepare corners. Install 5mm vertical spacer strip to vertical corner battens and install bond breaker tape for vertical joints that require sealant filling. The 5mm spacer is required at all face fixing locations (including corner joints). Note that, if backing rod is required, install after panel installation.

Step 4 – Install Corners (note if no external corner exists start installing panels at one end of the wall).

- A.** If installing pre-formed corners, place the first corner piece at the corner onto the starter strip. It is important to ensure that each corner piece is square on both sides. If the corners are not square, pack out the clips. Pre-drill holes into the corner piece and the adjoining panel allowing 20-35mm (or 30-40mm for steel) clearance from the edge. Fix through the batten and 5mm spacer with appropriate fasteners.
- B.** If installing aluminium corners, cut to length. Notch out to extend over the starter strip. To maintain the 5mm cavity, first tack vertical spacers on each side of the corner stud. Then, ensuring the metal corner is correctly positioned, nail or screw it through the spacer to the frame. The wall panel should fit into the corner's channel and slide down onto the starter strip.

Step 5 – Install wall panels. Place the first wall panel onto the starter strip. Position panel clips to tongue and groove edge of panels at every horizontal batten. Tap firmly into place and screw into place using 20mm Territory button head screws. Use 1 screw for head and base clips and 2 screws for all other clips. Pack out the clips if necessary to ensure a uniform fixing plane.

Continue to install the panels onto the starter strip. Continue to secure clips to the tongue of the panel, tap firmly into place and screw fix to battens. Where face fixing may be required, a strip of spacer (cut to a minimum length of 200mm) should be positioned between the panel and the frame thus maintaining the 5mm cavity.

Step 6 – Finishing at the wall head. Determine appropriate head detail. If installing a metal angle, install prior to fixing panel. Install spacer strip onto the top horizontal batten to maintain the 5mm cavity. Cut the top panel/prefinished corner 6-8mm shorter than the height of the wall to allow lifting of the final panel and dropping into place.

Step 7 – Caulk all expansion joints (ref Fig 7.13). Ensure the Territory panels are dry before applying primer and Territory Coloured Joint Sealant. Remove dust, grease, moisture and clean the joint to be caulked. Ensure bond breaker tape or backing rod is installed at vertical joints.

Apply masking tape to each side of the vertical joints and at the base, ensure the tape follows the caulk edge and surface profile. Paint the edges of the panels with the primer and immediately remove excess primer from the tape or main face of panel. The primer helps the sealant adhere to the panels. Wait a minimum 1 hour and maximum 4 hours before applying the sealant. Provide another primer coat for wait times greater than 4 hours.

Fully fill joint with sealant. Smooth off the finish with manufacturer recommended products, removing excess sealant.

Care must be taken when removing the masking tape to ensure no damage to the surface or edge of the caulked joint. Note: CARE NEEDS TO BE TAKEN NOT TO GET SEALANT AND/OR PRIMER ON THE MAIN FACE OF PANELS as this can result in marks and stains on the panel face.

Install sealant to gaps at windows and other penetrations.

Step 8 – Touch up any exposed fasteners. Wipe panels down with a damp cloth and touch up any exposed nail or screw heads with matching touch up paint.

INSTALLATION



FIGURE 7.13 Typical Method for Sealing Vertical Joints

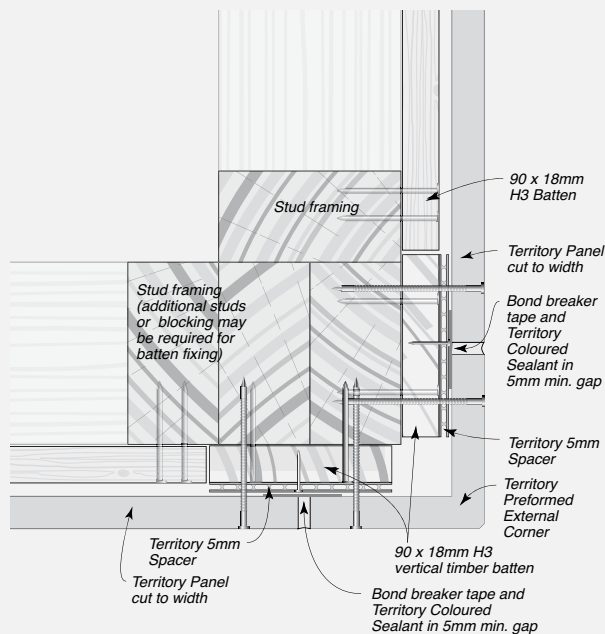
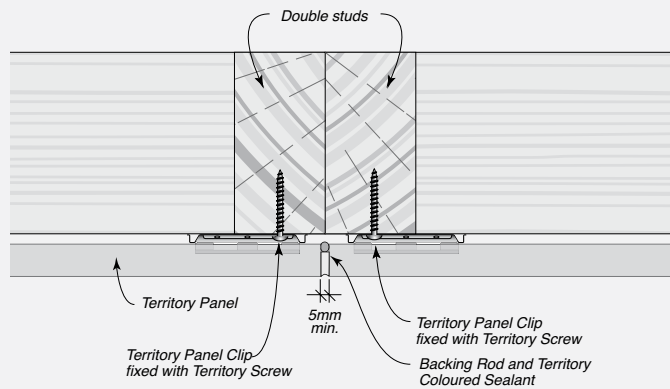
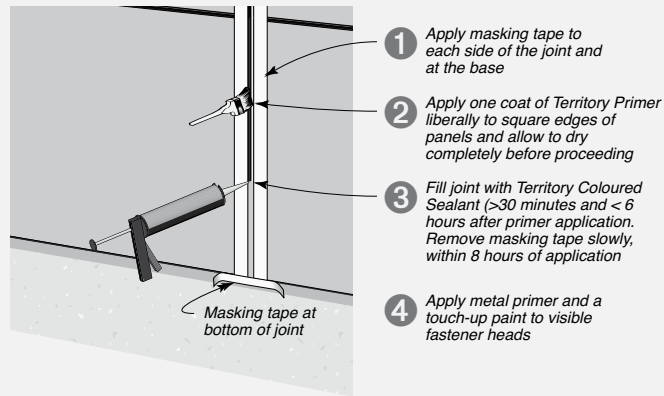

07

INSTALLATION

- | | | |
|-------------------------------------|------------------------------------|-----------------------|
| 1 Stud | 4 Vertical starter strip | 8 Panel |
| 2 90x18mm timber horizontal battens | 5 Vertical spacer strip | 9 Panel clip |
| 3 90x18mm timber vertical battens | 6 Bond breaker tape or backing rod | 10 Primer and sealant |
| | 7 Pre-formed vertical corner | 11 Face fixing |

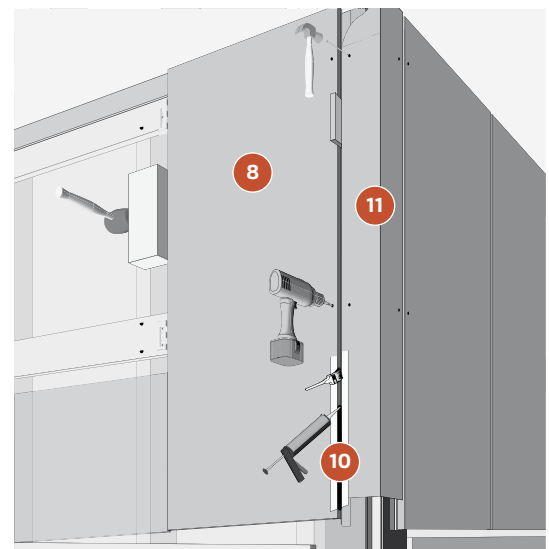
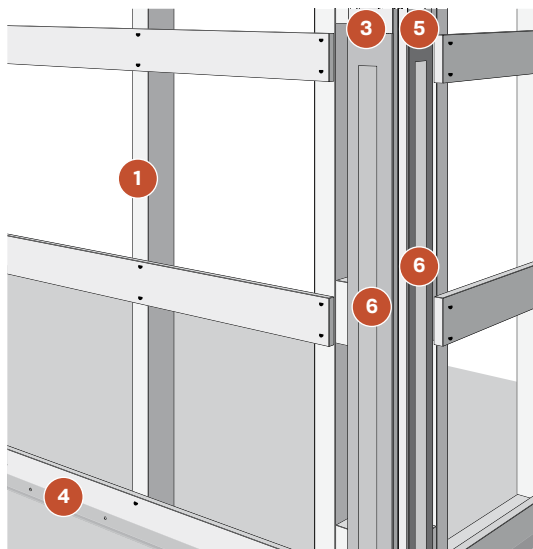
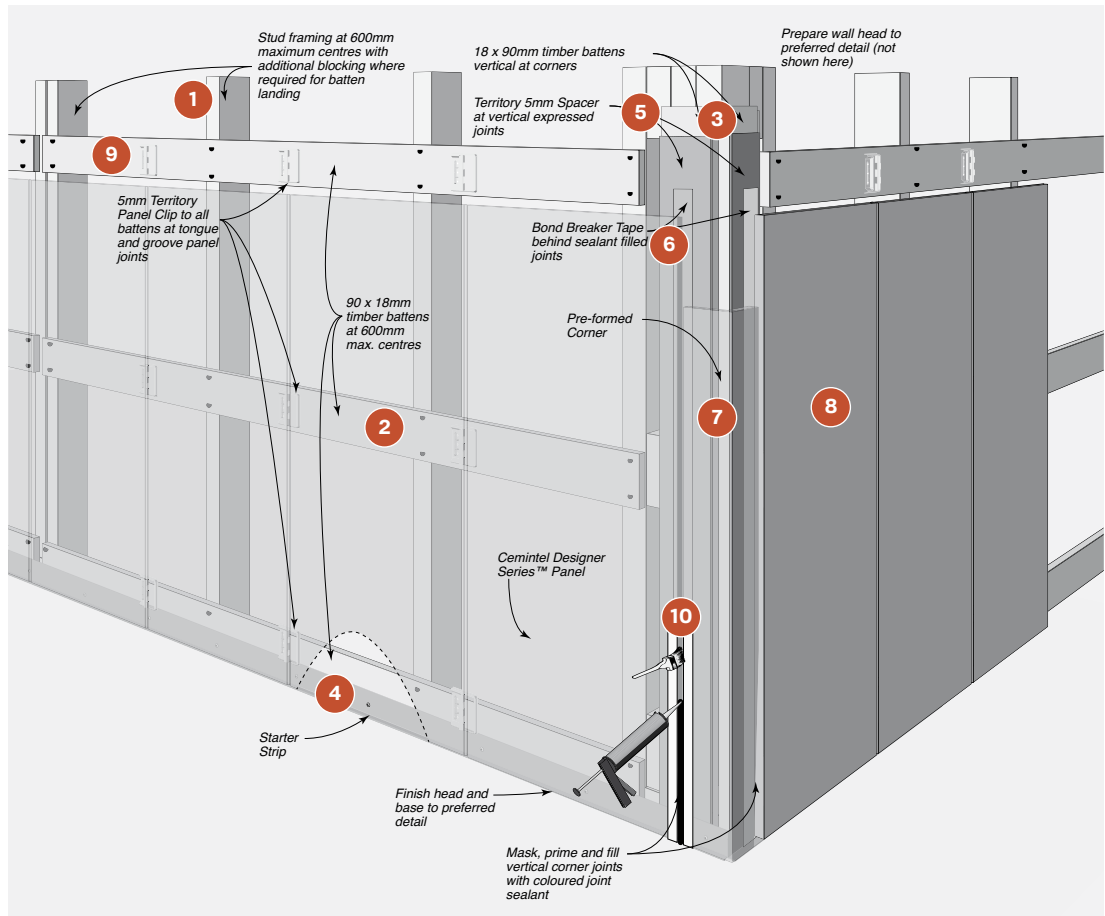



CONSTRUCTION
DRAWINGS + DETAILS



CONSTRUCTION DRAWINGS AND DETAILS

Note: Drawings are interchangeable for timber or steel substrates with the exception of the fasteners.

Drawings Index

SECTION	DESCRIPTION	FIGURE REFERENCE	PAGE NUMBER
HORIZONTAL INSTALLATION			
Base Details	Base Detail – No Skirting	8.01	35
	Base Detail – With Skirting	8.02	35
Corner Details*	Pre-formed External Corner – Plan View	8.03	35
	External Corner with Coloured External Corner Trim – Plan View	8.04	35
	Internal Corner with Backing Rod and Coloured Sealant – Plan View	8.05	36
	Obtuse Angle Corner with Metal Flashing and Coloured Sealant – Plan View	8.06	36
Junction Details	Head Detail – with coloured angle	8.07	36
	Head Detail – with Shadowline Trim	8.08	36
	Head Detail – with Cornice	8.09	37
	Typical Junction of Territory with Plasterboard Wall – Plan View	8.10	37
	Typical Junction of Territory with Masonry Wall – Plan View	8.11	37
	Typical Junction of Territory with Deep Masonry Wall – Plan View	8.12	37
*Additional studs may be required at corners to allow for fixing Territory panel clips, other components and to support joint backing rod.			
VERTICAL INSTALLATION			
Base Details	Base Detail – with Sealant	8.13	38
	Base Detail – with Skirting	8.14	38
Corner Details**	External Corner Detail – with Pre-formed Corner – Plan View	8.15	38
	External Corner Detail – with Coloured External Corner Trim – Plan View	8.16	38
	Internal Corner Detail – with Backing Strip and Coloured Sealant – Plan View	8.17	39
	Obtuse Angle Corner Detail – with Metal Flashing and Coloured Sealant – Plan View	8.18	39
Junction Details	Head Detail – with Sealant	8.19	39
	Head Detail – with Cornice	8.20	39
	Junction of Territory with In-Line Masonry Wall – Plan View	8.21	40
	Junction of Territory with Offset Masonry Wall – Plan View	8.22	40
	Typical Detail Junction with Fibre Cement Cladding System – Plan View	8.23	40
**Additional studs may be required at corners to allow for fixing of battens, panel clips and other components.			

CONSTRUCTION DRAWINGS AND DETAILS



Note: Drawings are interchangeable for timber or steel substrates with the exception of the fasteners.

Horizontal Installation

Base Details

FIGURE 8.01 Base Detail – No Skirting

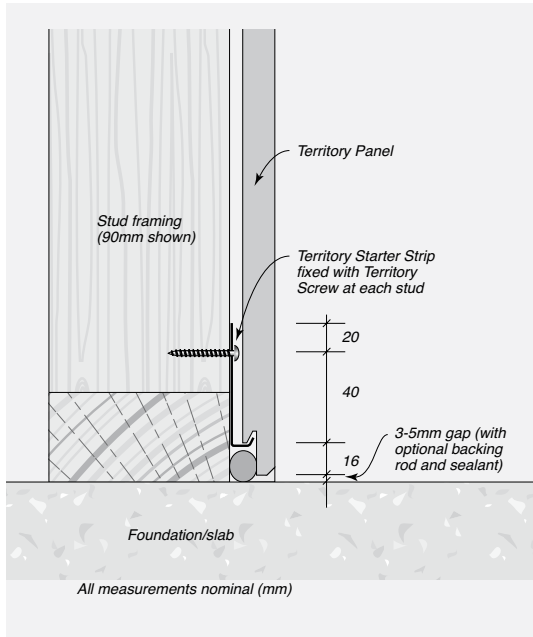
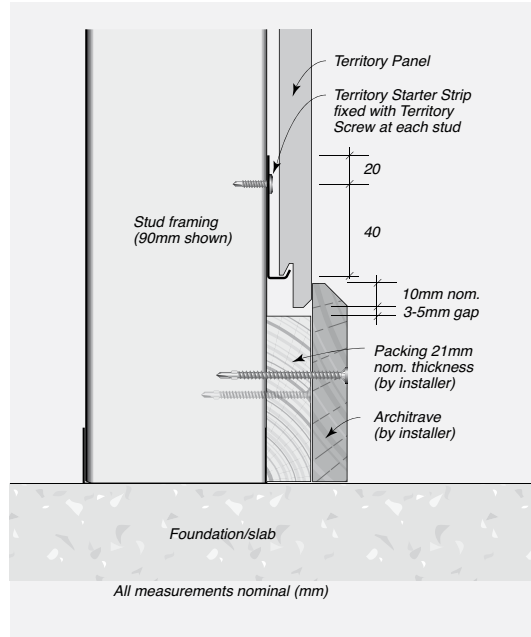

FIGURE 8.02 Base Detail – With Skirting



Corner Details

Additional studs may be required at corners to allow for fixing Territory Panel Clips, other components and to support joint backing rod.

FIGURE 8.03 Performed External Corner – Plan View

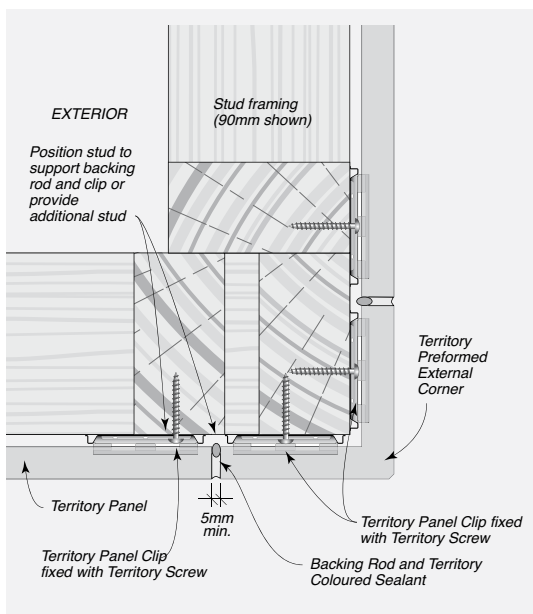
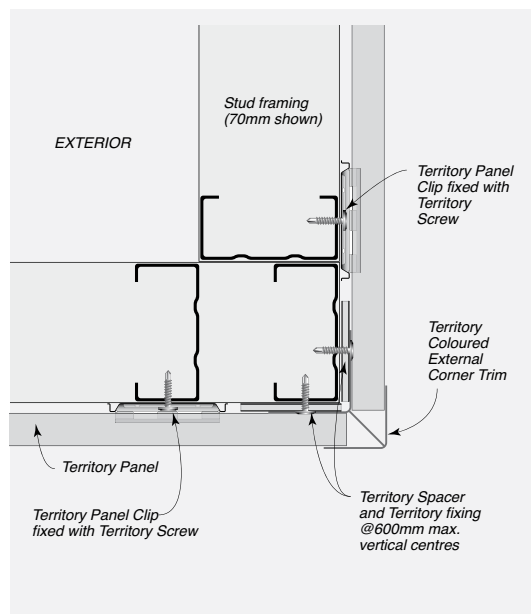

FIGURE 8.04 External Corner with Coloured External Corner Trim – Plan View





CONSTRUCTION DRAWINGS AND DETAILS

Note: Drawings are interchangeable for timber or steel substrates with the exception of the fasteners.

FIGURE 8.05 Internal Corner with Backing Rod and Coloured Sealant – Plan View

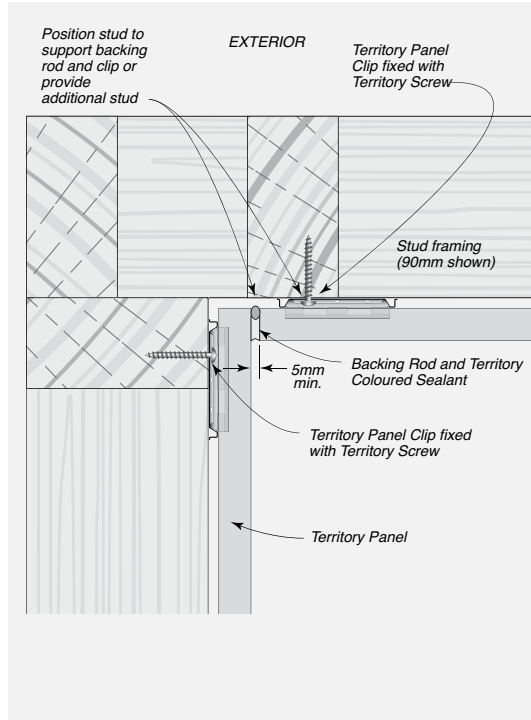
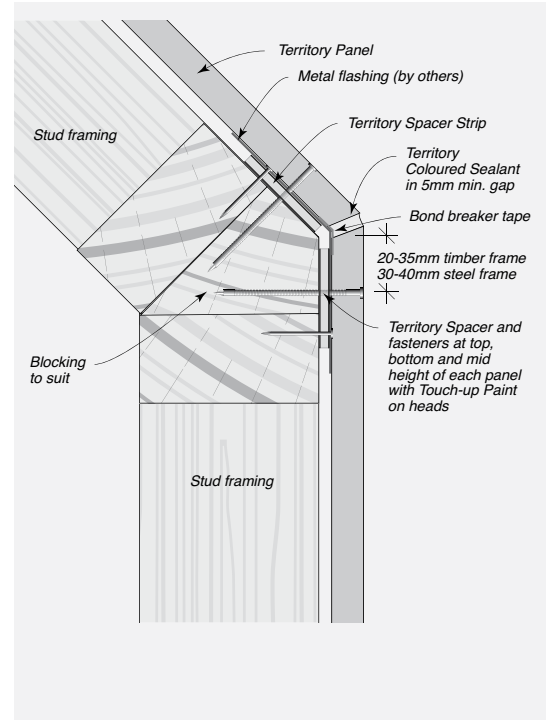

FIGURE 8.06 Obtuse Angle Corner with Metal Flashing and Coloured Sealant – Plan View



Junction Details

FIGURE 8.07 Head Detail – With Coloured Angle

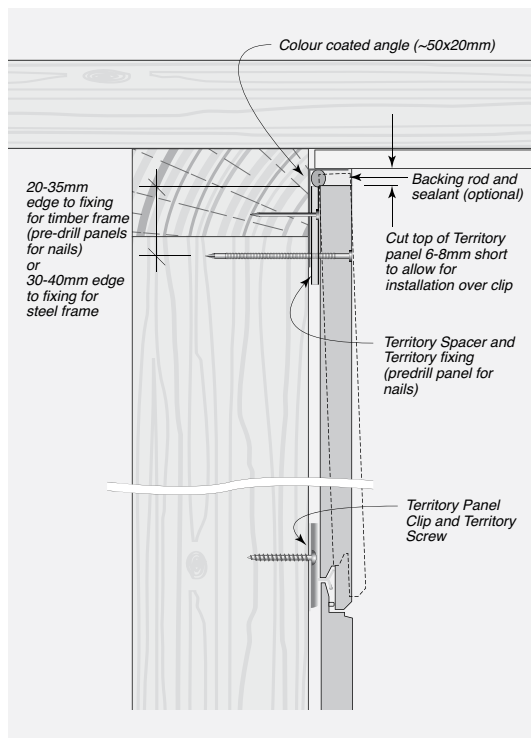
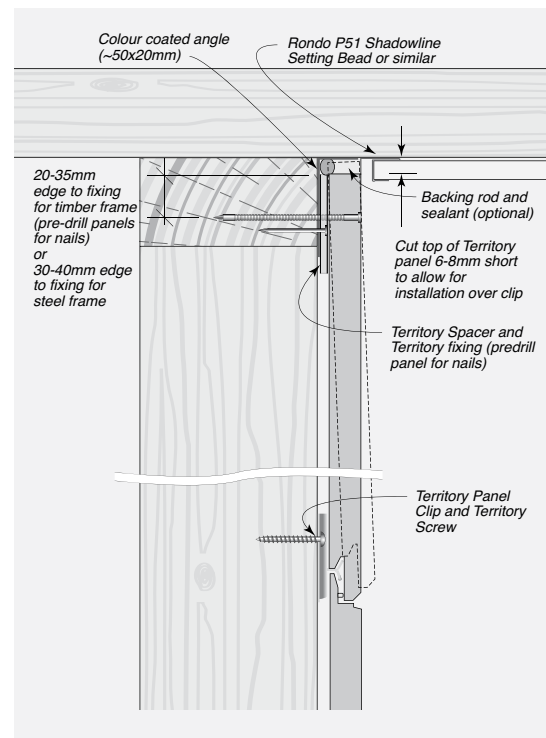

FIGURE 8.08 Head Detail – With Shadowline Trim



CONSTRUCTION DRAWINGS AND DETAILS



Note: Drawings are interchangeable for timber or steel substrates with the exception of the fasteners.

FIGURE 8.09 Head Detail – With Cornice

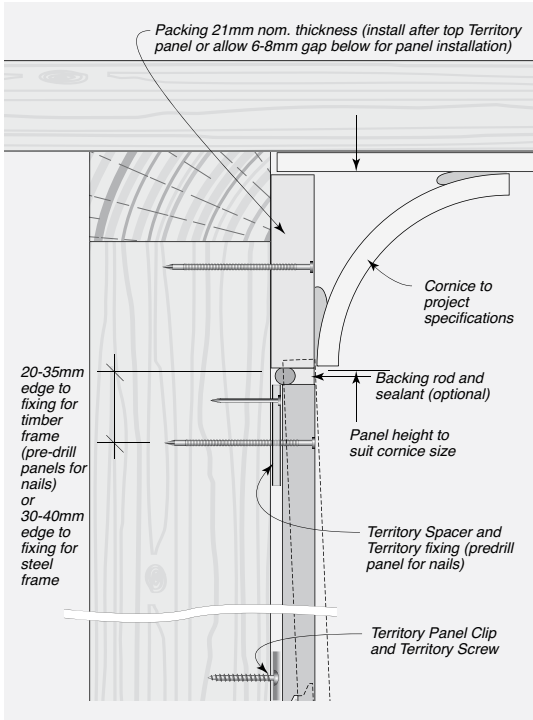

FIGURE 8.10 Typical Junction with Plasterboard Wall – Plan View

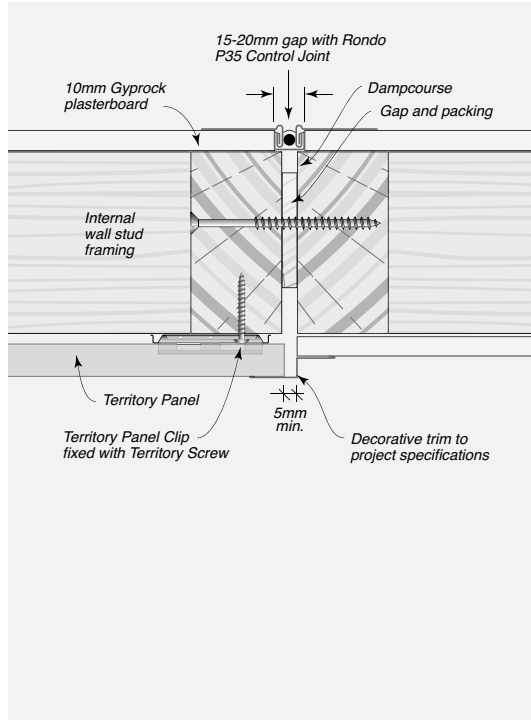

FIGURE 8.11 Typical Junction with Masonry Wall – Plan View

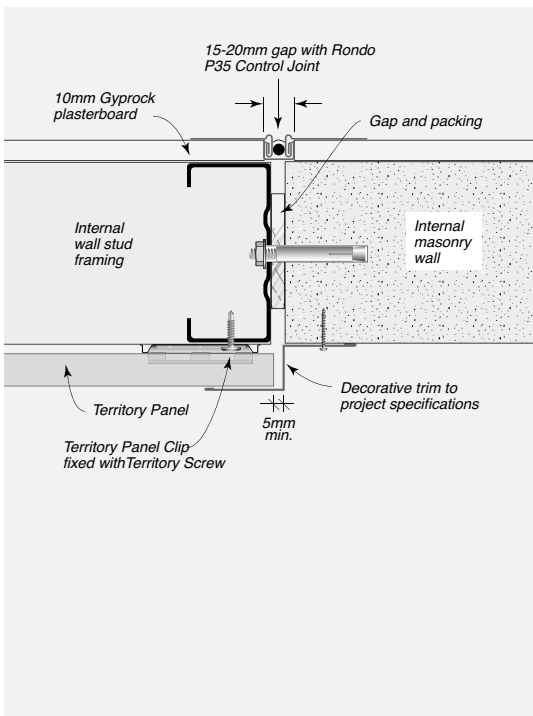
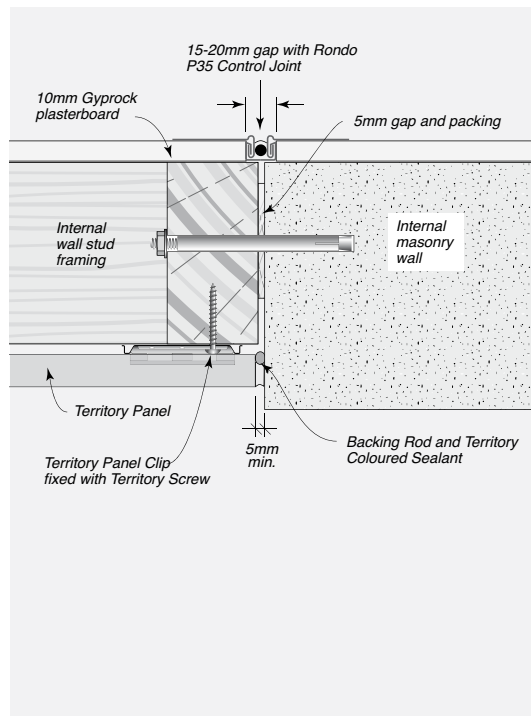

FIGURE 8.12 Typical Junction with Deep Masonry Wall – Plan View





CONSTRUCTION DRAWINGS AND DETAILS

Note: Drawings are interchangeable for timber or steel substrates with the exception of the fasteners.

Vertical Installation

Base Details

FIGURE 8.13 Base Details – With Sealant

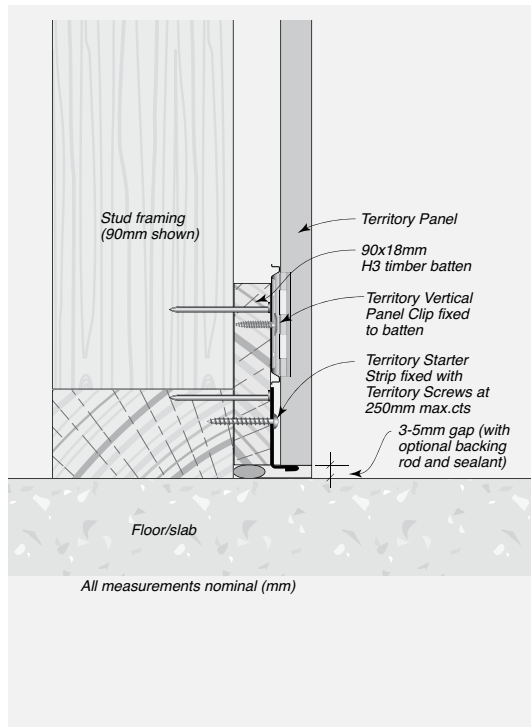
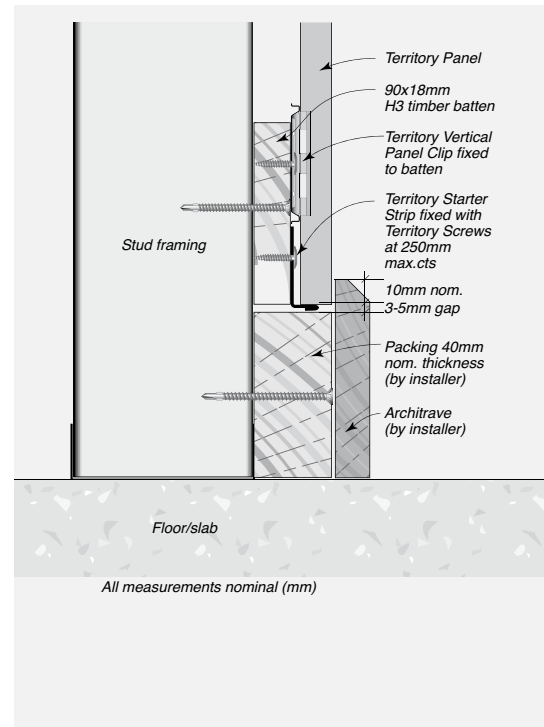

FIGURE 8.14 Base Detail – With Skirting



Corner Details

Additional studs may be required at corners to allow for fixing battens, Territory Panel Clips, other components.

FIGURE 8.15 External Corner Detail – With Performed Corner – Plan View

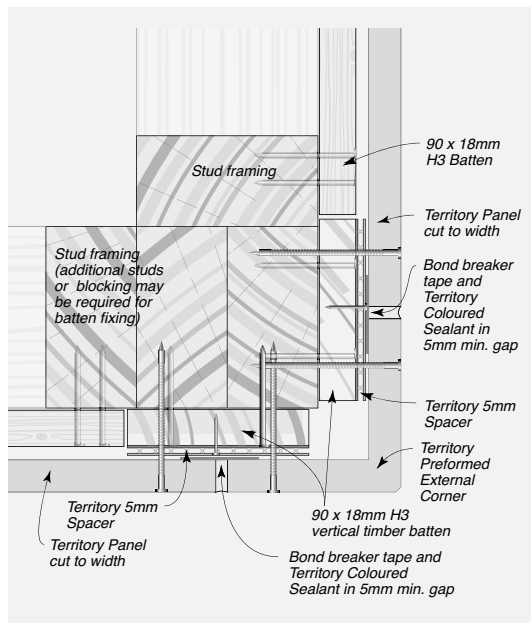
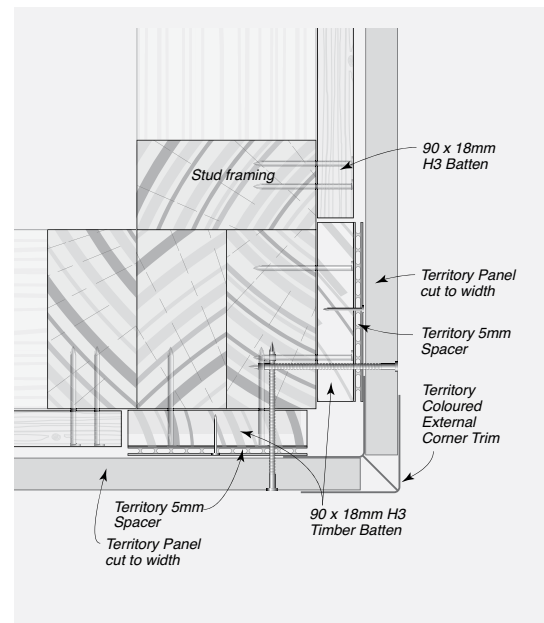

FIGURE 8.16 External Corner Detail – With Coloured External Corner Trim – Plan View



CONSTRUCTION DRAWINGS AND DETAILS



Note: Drawings are interchangeable for timber or steel substrates with the exception of the fasteners.

FIGURE 8.17 Internal Corner Detail – With Backing Strip and Coloured Sealant – Plan View

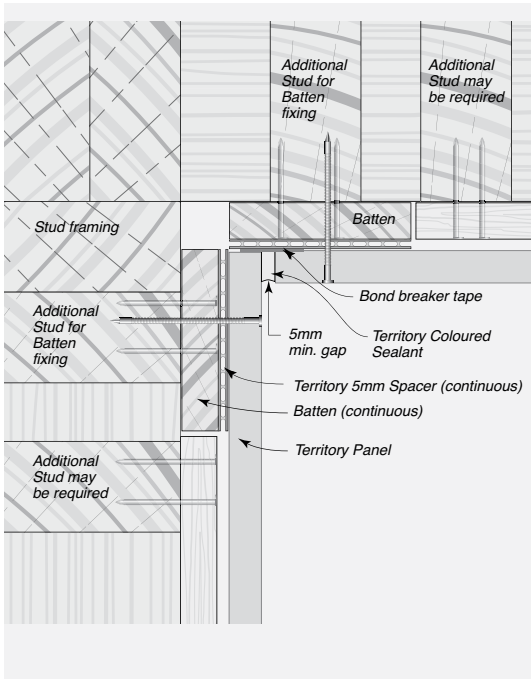
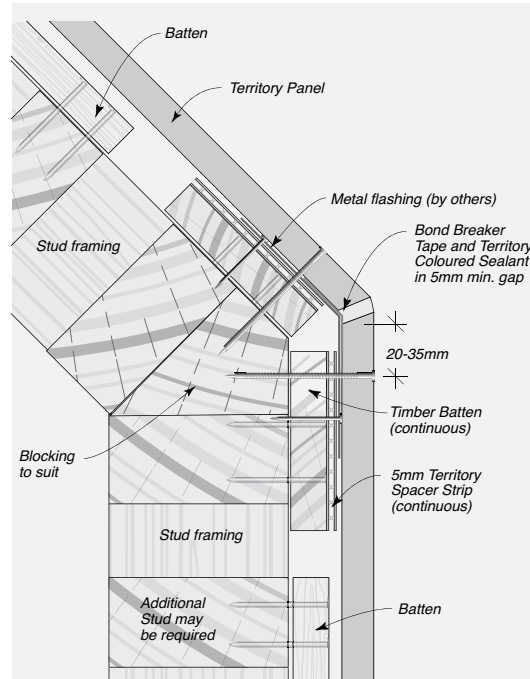

FIGURE 8.18 Obtuse Angle Corner Detail – With Metal Flashing and Coloured Sealant – Plan View



Junction Details

FIGURE 8.19 Head Detail – With Sealant

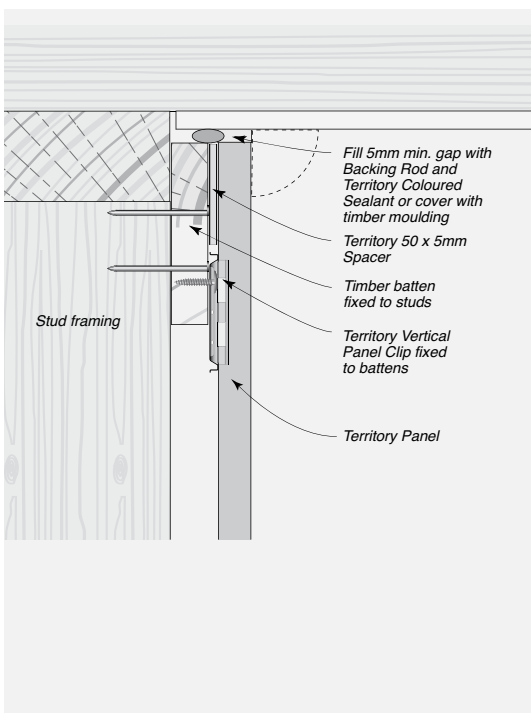
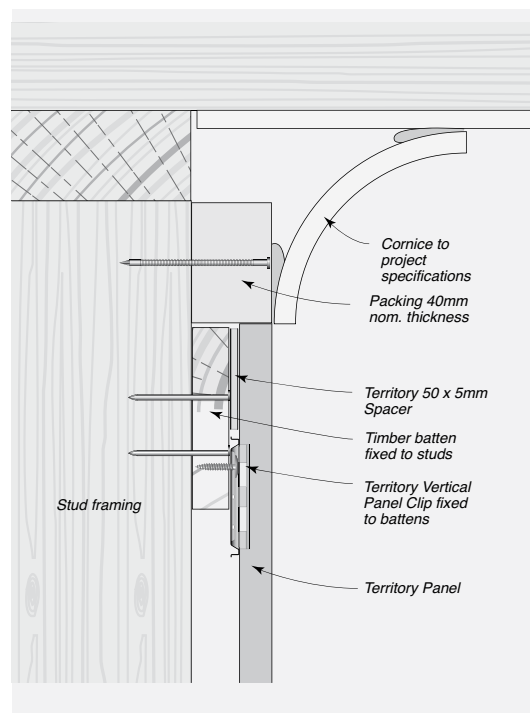

FIGURE 8.20 Head Detail – With Cornice





CONSTRUCTION DRAWINGS AND DETAILS

Note: Drawings are interchangeable for timber or steel substrates with the exception of the fasteners.

FIGURE 8.21 Junction In-line Masonry Wall – Plan View

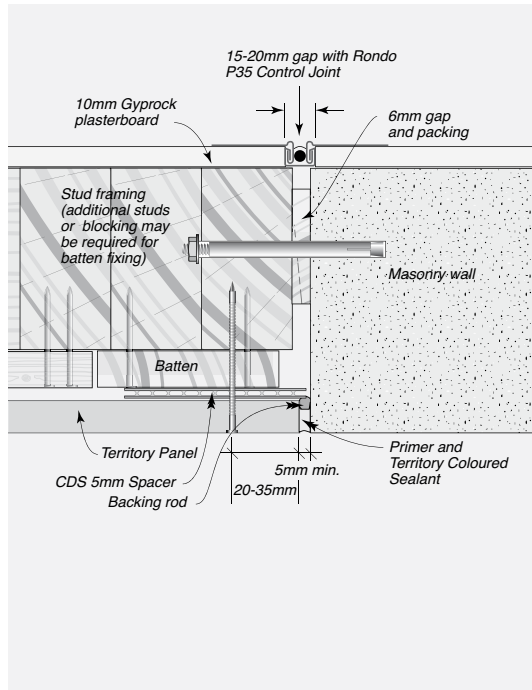

FIGURE 8.22 Junction Offset Masonry Wall – Plan View

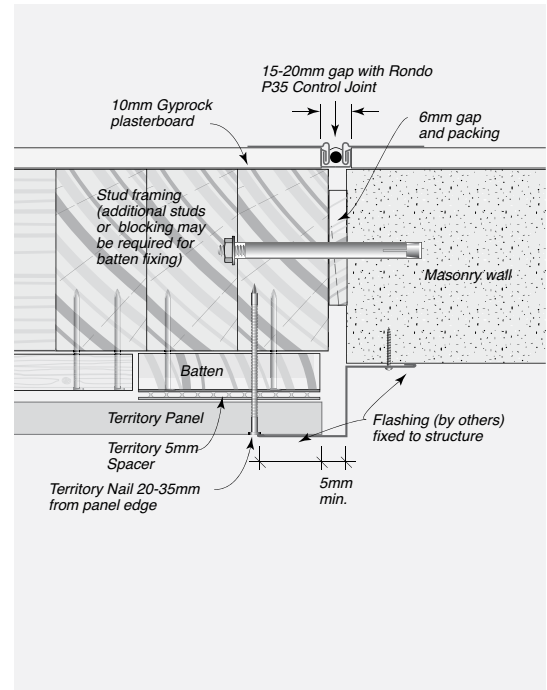
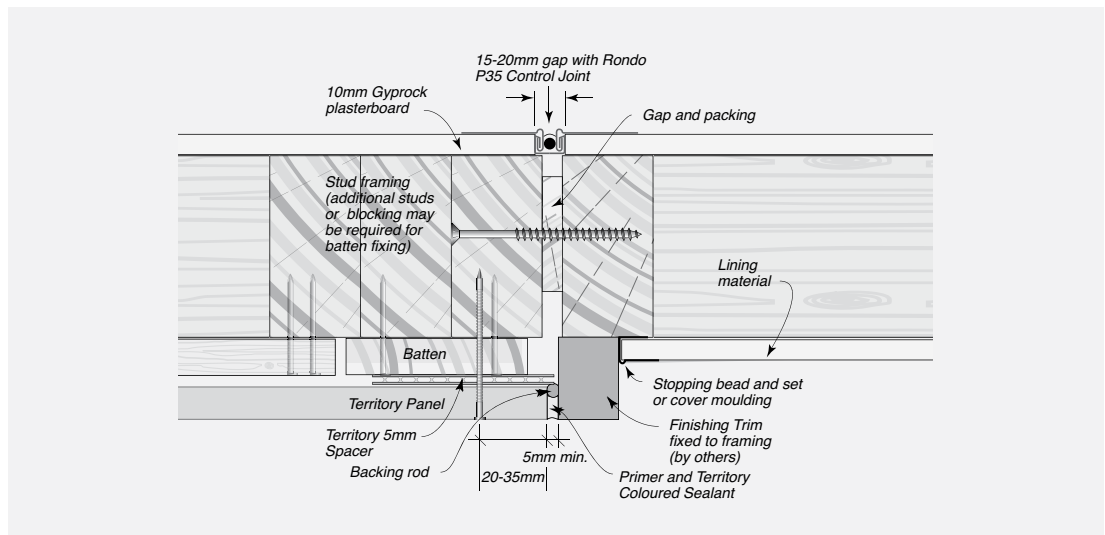

FIGURE 8.23 Typical Detail Junction with Fibre Cement Cladding System – Plan View





SAFETY, HANDLING, GENERAL CARE
+ WARRANTY



SAFETY, HANDLING, GENERAL CARE + WARRANTY

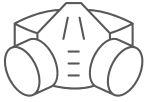

Health, Safety and Personal Protection Equipment (PPE)

Fibre Cement contain silicas that are harmful if inhaled. Protective clothing and breathing equipment should be worn when cutting products.

When cutting, drilling or grinding fibre cement panels using power tools, always ensure the work area is properly ventilated.

An approved dust mask (AS/NZS 1715 and AS/NZS 1716) and safety glasses (AS/NZS 1337) must be worn. Cemintel recommends that hearing protection also be worn.

Safety Data Sheet information is available at www.cemintel.com.au



Managing Respirable Crystalline Silica Dust

Crystalline Silica is everywhere. It is found naturally in stone, rocks, sand, gravel and clay. Sand is one of the raw materials in Fibre Cement. Respirable Crystalline Silica dust is the fine dust that's created when you use power tools to cut, drill, grind, chip or sand materials and products that contain crystalline

silica. This dust is of concern due to its size as it gets caught deep in your lungs and can cause long term damage.

IF YOU USE THE CORRECT SAFETY EQUIPMENT AND PPE, FIBRE CEMENT IS SAFE TO USE.



Cemintel Safety Requirements

1 - Cut Outdoors*	The ventilation outdoors is greater than that indoors, and therefore should reduce exposure.
2 - Use On-Tool Dust Extraction	Use on-tool dust extraction when using power tools to drill and cut Fibre Cement, with a vacuum that contains a HEPA M Class filter.
3 - Correct Saw and Blade	Use a plunge saw with a specifically designed Fibre Cement blade.
4 - Don't Sweep, Vacuum instead	When completing your work vacuum with a HEPA M Class filter, rather than a broom as sweeping creates more dust.
5 - Use Correct Respirator	Use a half face P1 or P2 respirator. It is essential that the respirators are Fit Tested and workers are cleanly shaven to obtain a good seal.

* Even though not recommended, indoor cutting can be completed when using an onsite cutting room with exhaust ventilation and a M class filter at a minimum, on-tool dust extraction with a vacuum with a HEPA M Class filter, a Full Face P2 respirator and conducting local occupational and static air monitoring to validate effectiveness of control measures.

Handling & General Care

Storage

All Territory panels must be stacked flat, clear of the ground and supported at 300mm maximum centres on a level platform. Panels must be kept dry, preferably stored inside the building. Panels must be dry prior to fixing, hence if it is necessary to store outside, the product must be protected from the weather.

Handling

Territory panels and corners are pre-finished products and must be treated with care during handling so as to avoid damage to edges, ends and pre-finished surface. Panels should be carried horizontally on edge by two people.

As the Territory range is a pre-finished product, consideration should be given to the activity of other tradespeople, in particular, a brick cleaner. It is highly recommended that installation of Territory should always be held off until the process of brick cleaning has been completed so as to avoid damage.

Cutting

Panels should be cut from the back using a power saw. Cemintel recommends using the FESTOOL TS 55 EBQ Plunge Cut Saw or Makita Plunge Saw with guide rail and appropriate blade. All exposed cut edges such as the window heads and roof junctions must be sealed with Cemintel edge sealer. Refer to 'Components + Accessories' table for appropriate materials.

Mitreing of Panels

It is not recommended to mitre panels as this can cause delamination of the face.

Face Fixing of Panels

At face fixing points, all panels must be supported by a Spacer Strip of 200mm minimum length. Panels must be pre-drilled to accept nails. Use a 2.5mm drill bit and drill from the front. Nail/screw heads should finish flush with the panel surface. All visible nail/screw heads should be neatly covered with primer and coloured painted used sparingly. Do NOT use sealant on nail heads.

Penetrations

Penetrations in panels may be cut or drilled prior to installation. Cut from the back or drill from the front. Cut penetrations oversize by 8-10mm all around. Mask, prime and fill gaps with sealant in accordance with recommended methods and products.

Bevelled Edges

The top edge of panels at window sill level may require bevelling. Cemintel recommends using the FESTOOL DSC-AGP 125 Diamond Blade Cutting & Grinding Tool.

Warranty

The Cemintel Territory panels have a product warranty of 10 years.

The full Cemintel Territory product warranty is available for download at cemintel.com.au

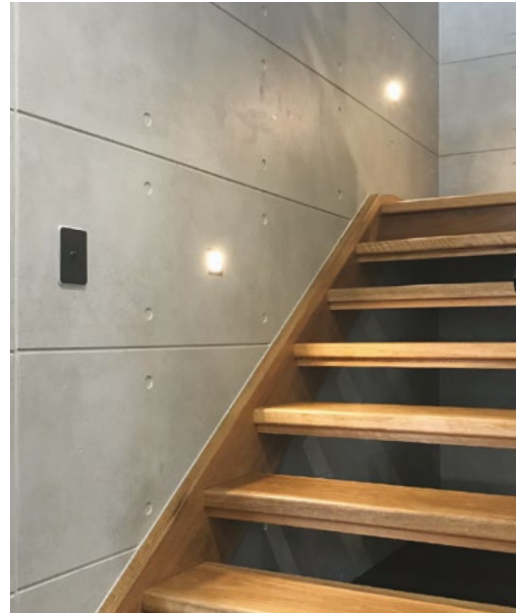



Our Offices

Sydney

376 Victoria Street
Wetherill Park NSW 2164

Adelaide

Lot 100 Sharp Court
Mawson Lakes SA 5095

Darwin

Cnr Stuart Highway
& Angliss Street
Berrimah NT 0828

Melbourne

277 Whitehall Street
Yarraville VIC 3013

Perth

19 Sheffield Road
Welshpool WA 6106

Brisbane

768 Boundary Road
Coopers Plains QLD 4108

Hobart

11 Farley Street
Derwent Park TAS 7009

cemintel.com.au
1300 236 468

For Design and Technical Support:
DesignLINK – 1800 621 117

Cemintel is a trading entity of CSR Building Products Limited (ACN 008 631 356).

The products referred to in this document have been manufactured by or on behalf of CSR Building Products Limited ("CSR") to comply with the National Construction Code (NCC) and any relevant Australian Standards. While any design or usage guidelines set out in this document have been prepared in good faith by CSR, they are of a general nature only and are intended to be used in conjunction with project specific design and engineering advice.

It is the responsibility of the customer to ensure that CSR's products are suitable for their chosen application, including in respect of project-specific matters such as, but not limited to structural adequacy, acoustic, fire resistance/combustibility, thermal, and weatherproofing requirements. All information relating to design/installation/application of these products is offered without warranty and no responsibility can be accepted by CSR for errors and omissions, or for any use of the relevant products not in accordance with CSR's technical literature or any other relevant industry standards. For current technical and warranty documentation relating to Cemintel's products, visit Cemintel's website at www.cemintel.com.au.

04/2026